

VOGLIA DI CRESCERE

PROGRAMMA BASE PER LO SVILUPPO LOGICO E COGNITIVO

Emidio Tribulato

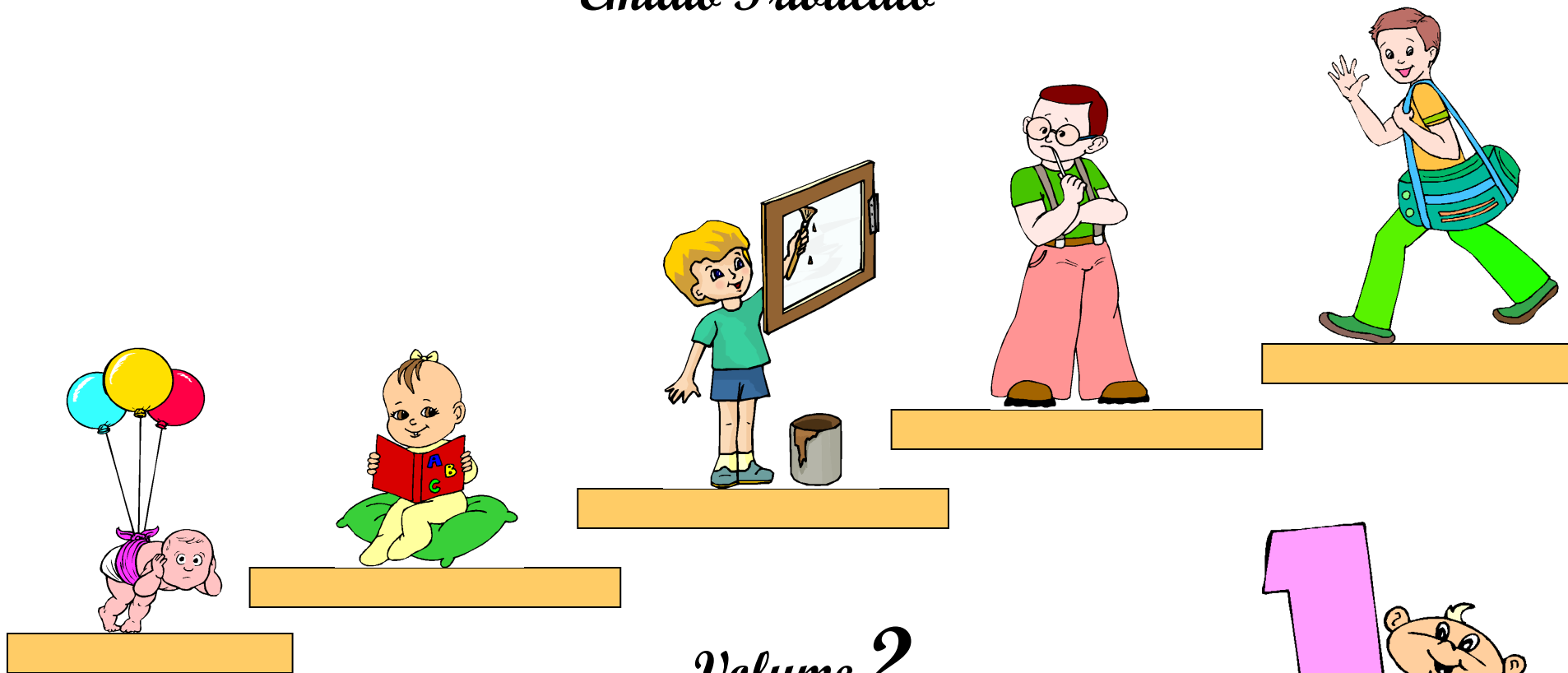

Volume 2

Livello

Centro studi LOGOS - ONLUS - Messina



CENTRO STUDI LOGOS
ONLUS
CENTRO DI RICERCHE PSICOPEDAGOGICHE
VIA PRINCIPE TOMMASO 2 - MESSINA
TEL. 090/46920
DIRETTORE: DOTT. EMIDIO TRIBULATO

“ VOGLIA DI CRESCERE ”

PROGRAMMA BASE PER LO SVILUPPO LOGICO E COGNITIVO

Emidio Tribulato

INDICE

| | |
|--|---------------|
| <i>ASSOCIAZIONE DI IMMAGINI UGUALI O SIMILI</i> | <i>Pag. 3</i> |
| <i>I PERCORSI</i> | <i>“ 45</i> |
| <i>ASSOCIAZIONI DI FIGURE GEOMETRICHE UGUALI</i> | <i>“ 74</i> |
| <i>ASSOCIAZIONI LOGICHE</i> | <i>“ 154</i> |



2005 - Tutti i diritti riservati. Emidio Tribulato Viale Annunziata 72
Messina – Tel. 090357149 - 09046920

E - mail: logos.messina@tiscali.it --- Nuovo sito web: www.cslogos.it

Vol. I

Livello 2

SIGLATURA

Per avere una visione immediata di come procede, nel minore, l'apprendimento è bene che questo venga evidenziato mediante dei simboli.

E' fondamentale, infatti, che l'educatore abbia presente, in ogni momento, quali schede o attività siano dal bambino conosciute, sconosciute o in via di acquisizione. Ciò per evitare di farlo confrontare con temi troppo complessi senza aver prima consolidato gli apprendimenti più semplici, o di far ripetere inutilmente schede e attività da lui perfettamente conosciute e quindi superate.

Si consiglia pertanto di siglare sia le singole schede che le attività globali indicate nell'indice sottostante indicando con:

 un puntino l'inizio dell'apprendimento;

 una crocetta, le schede o le attività in cui il bambino dà risposte esatte ma senza il commento verbale minimo richiesto, ad esempio il nome dell'oggetto;

 un cerchio che circonda una crocetta, per indicare le schede o le attività in cui il bambino dà un commento verbale minimo.

 un quadrato che include un cerchio ed una crocetta, per indicare le schede o le attività di cui il bambino ha completato l'apprendimento.

LIVELLI DI APPRENDIMENTO

• ASSOCIAZIONI DI IMMAGINI UGUALI O SIMILI

• I PERCORSI

• ASSOCIAZIONI DI FIGURE GEOMETRICHE UGUALI

• ASSOCIAZIONI LOGICHE

“ VOGLIA DI CRESCERE ”

PROGRAMMA BASE PER LO SVILUPPO LOGICO E COGNITIVO

ASSOCIAZIONI DI IMMAGINI UGUALI

ASSOCIAZIONI DI IMMAGINI UGUALI

La possibilità di stimolazione logica fino ai tre anni, in pratica coincide per lo più con la possibilità dello sviluppo psicomotorio, percettivo e del linguaggio.

Il bambino, infatti, manifesta le sue capacità logiche attraverso un'attività rivolta soprattutto all'analisi, confronto e interpretazione della realtà sensoriale.

Nella sua esplorazione del mondo vengono ad essere coinvolti tutti i sensi per cui è importante una molteplicità di stimolazioni.

Maggiore attenzione noi diamo alla percezione uditiva e visiva, in quanto è più facile, per gli studiosi e per gli educatori in genere, preparare e somministrare materiale graduato e opportunamente variato composto da immagini, da suoni e parole, piuttosto che da gusti e da odori.

Le schede che qui presentiamo sono formate da immagini uguali o simili da riconoscere e da associare che hanno lo scopo di sviluppare nel bambino non solo la percezione visiva ma anche il linguaggio, i primi processi di astrazione e i fondamentali rapporti spaziali.

Il bambino viene inoltre arricchito da numerosi elementi culturali.

In tali schede sono presenti delle immagini nella parte alta da associare con quelle corrispondenti nella parte bassa.

UTILIZZAZIONE

Per un corretto uso di tali schede è opportuno seguire due fasi:

I fase

Inizialmente l'educatore dirà il nome dell'immagine di cui chiede l'associazione, ed è sufficiente in questa prima frase che il bambino risponda con un semplice gesto della mano.

Nel caso di bambini molto piccoli o inibiti l'educatore potrà tenere con la sua la mano del bambino in modo tale da incoraggiarlo e avviarlo al gioco associativo.

II fase

Quando il bambino avrà acquisito un adeguato sviluppo del linguaggio sarà lui stesso a verbalizzare il nome delle immagini più semplici mentre effettuerà l'associazione.

ETA' MENTALE DI RIFERIMENTO

Due anni.

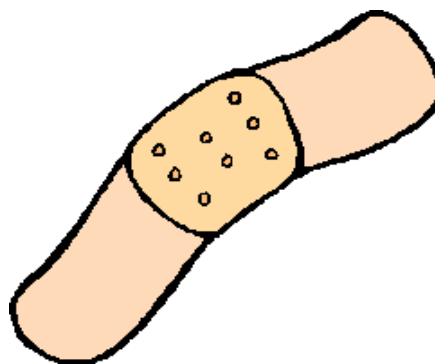

ASSOCIAZIONI DI IMMAGINI UGUALI
Dopo averle denominate far associare le immagini uguali.

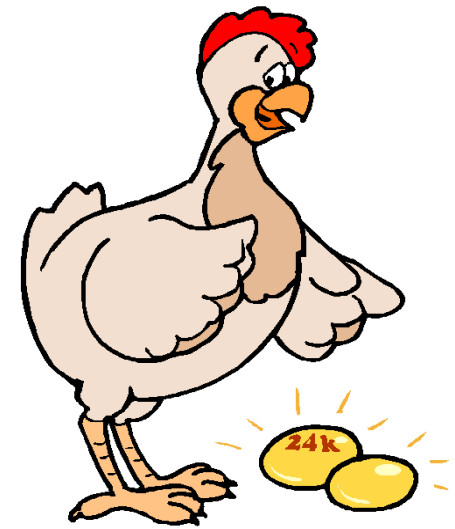
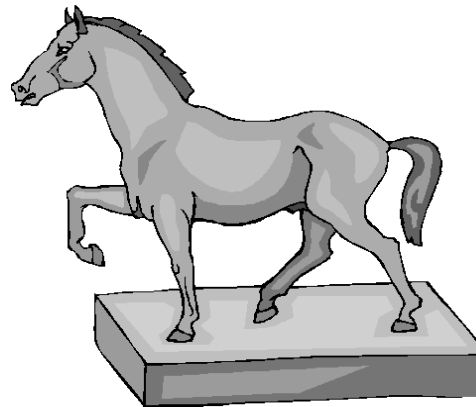
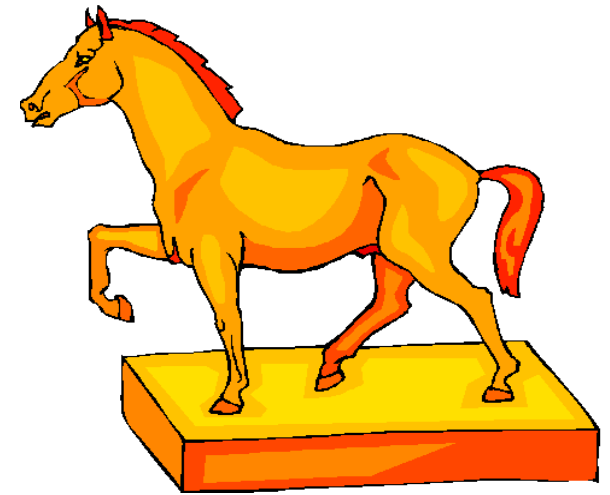
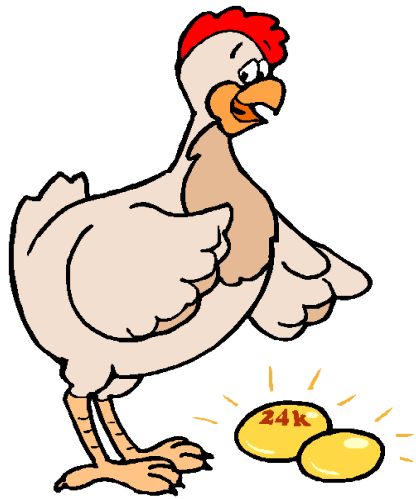

ASSOCIAZIONI DI IMMAGINI UGUALI
Dopo averle denominate far associare le immagini uguali.

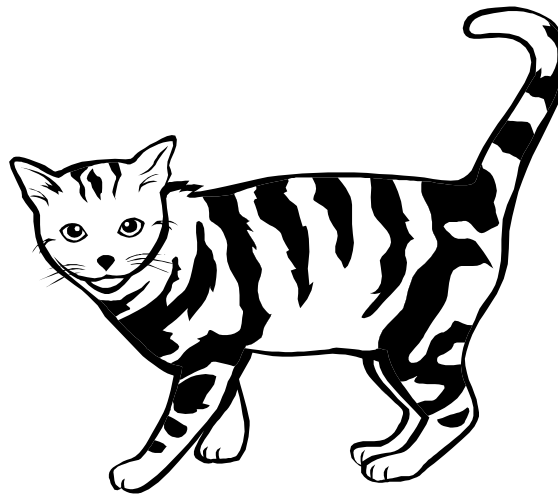
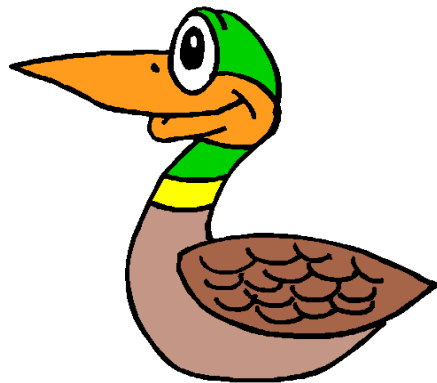
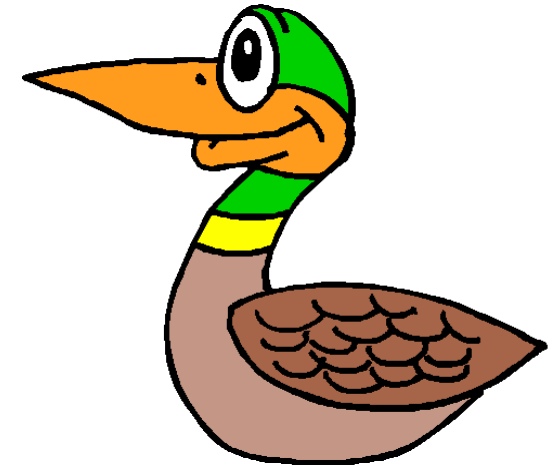
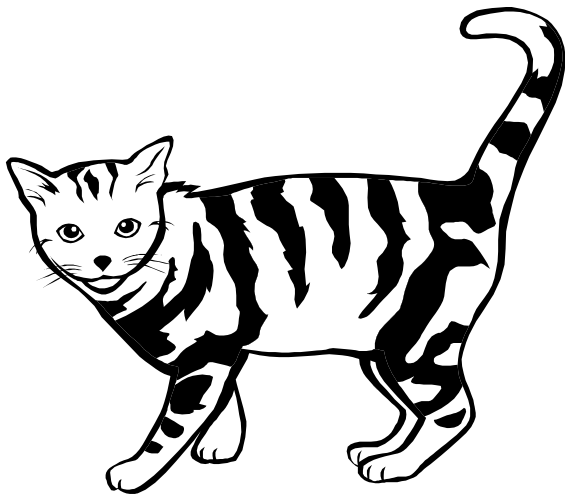

ASSOCIAZIONI DI IMMAGINI UGUALI
Dopo averle denominate far associare le immagini uguali.

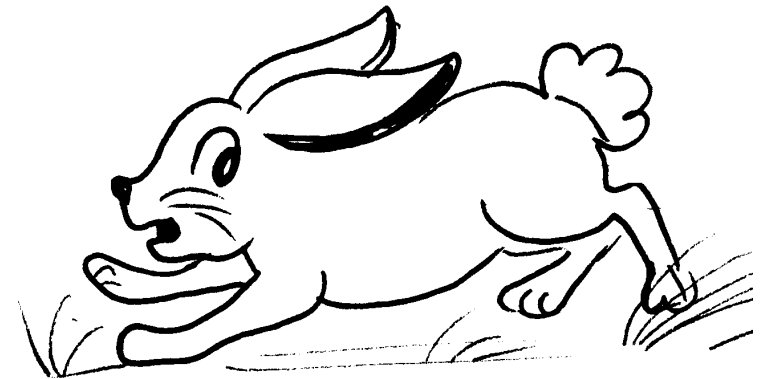
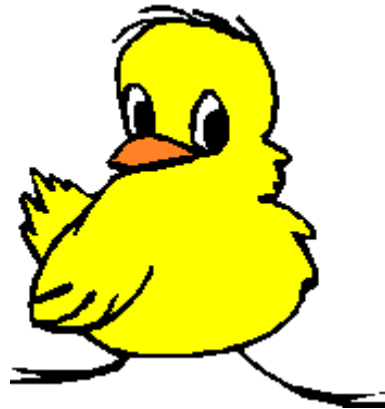
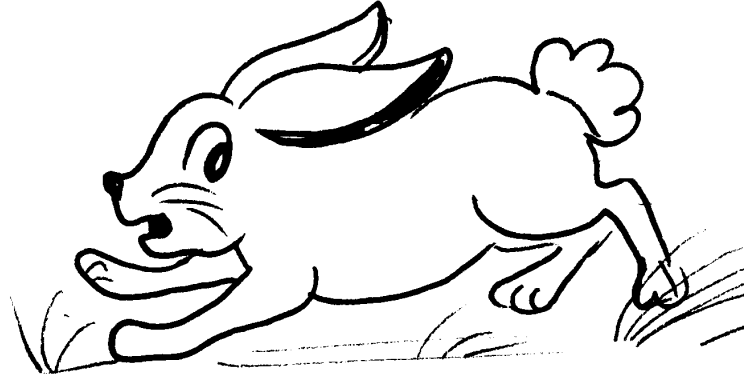

ASSOCIAZIONI DI IMMAGINI UGUALI
Dopo averle denominate far associare le immagini uguali.

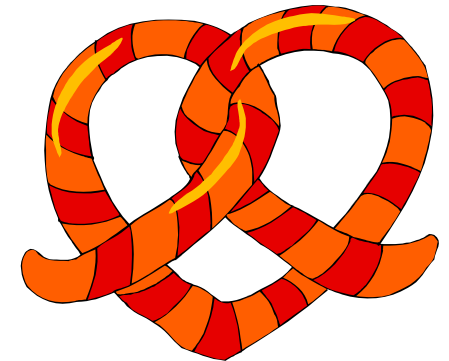
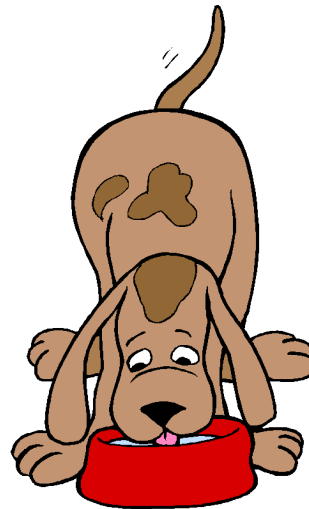
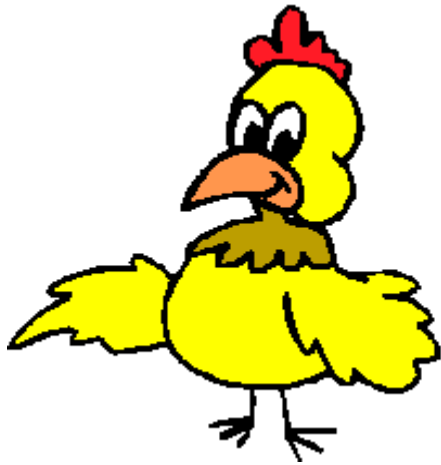
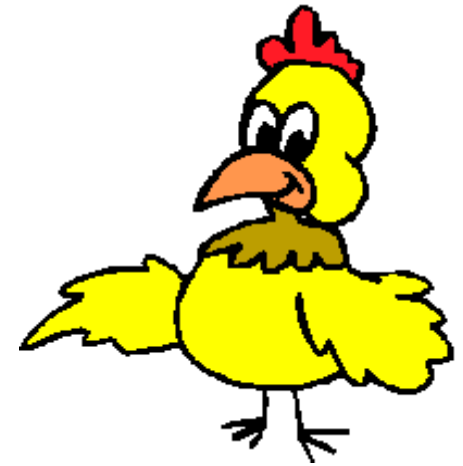
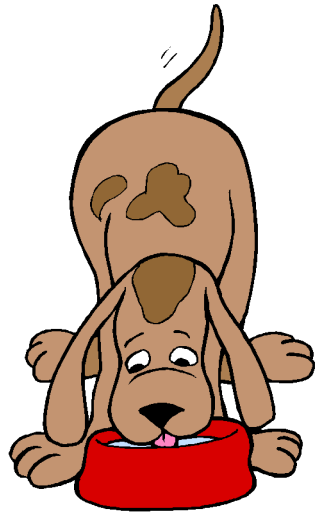

ASSOCIAZIONI DI IMMAGINI UGUALI
Dopo averle denominate far associare le immagini uguali.

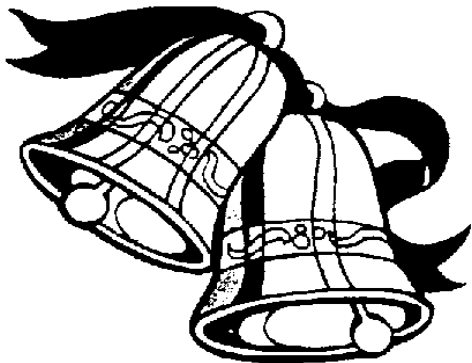

ASSOCIAZIONI DI IMMAGINI UGUALI
Dopo averle denominate far associare le immagini uguali.

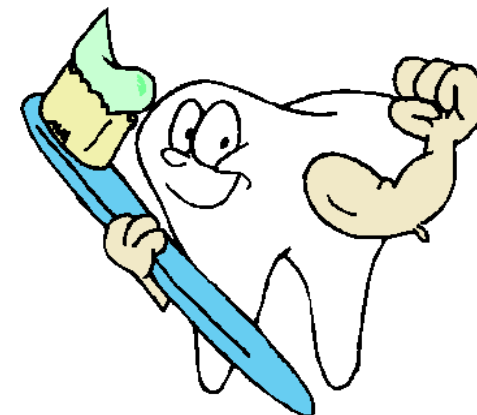
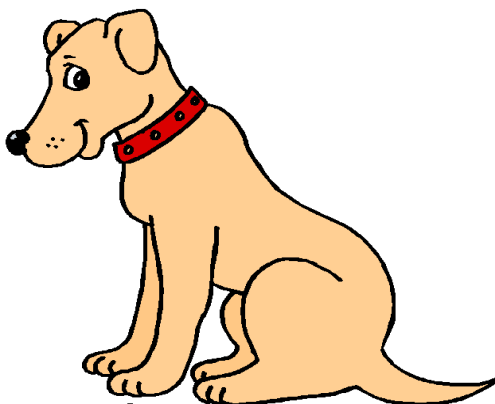
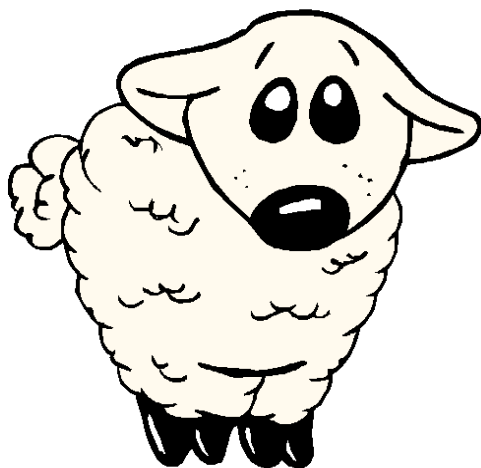
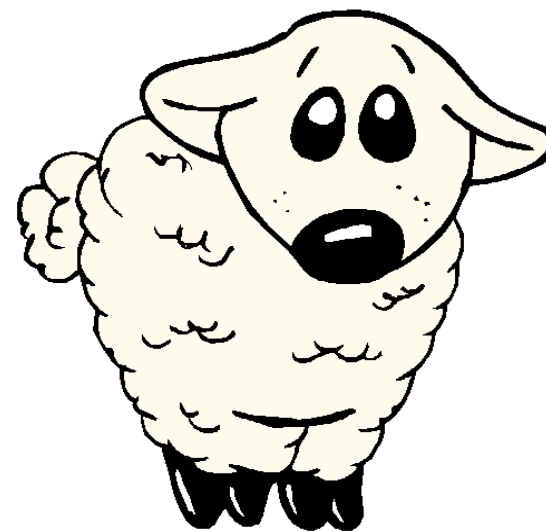
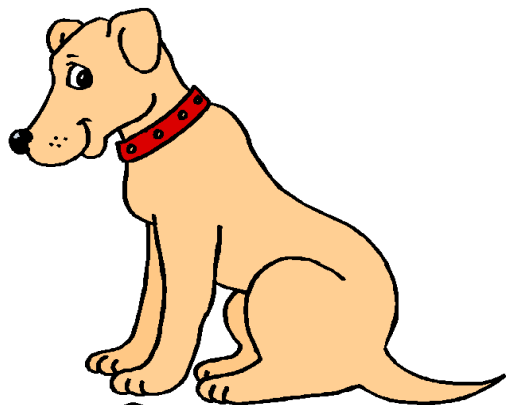

ASSOCIAZIONI DI IMMAGINI UGUALI
Dopo averle denominate far associare le immagini uguali.

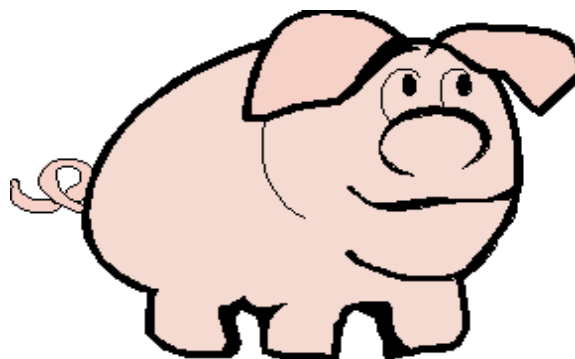
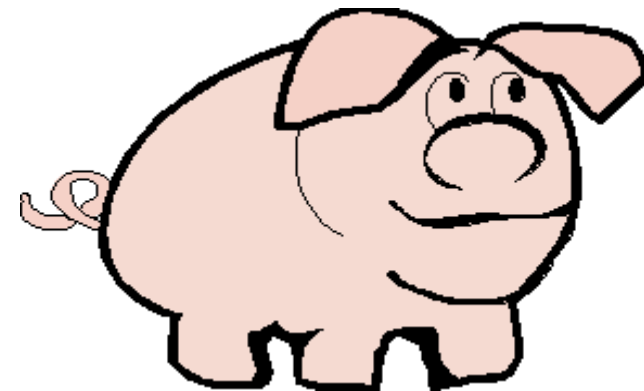

ASSOCIAZIONI DI IMMAGINI UGUALI
Dopo averle denominate far associare le immagini uguali.

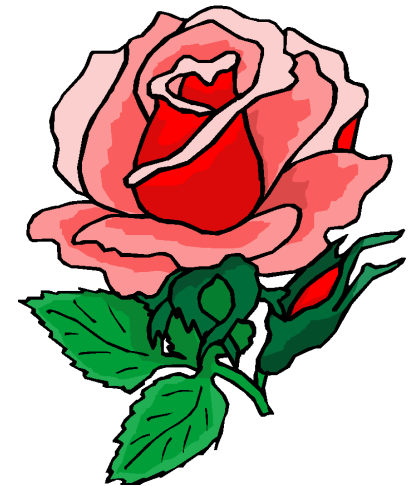
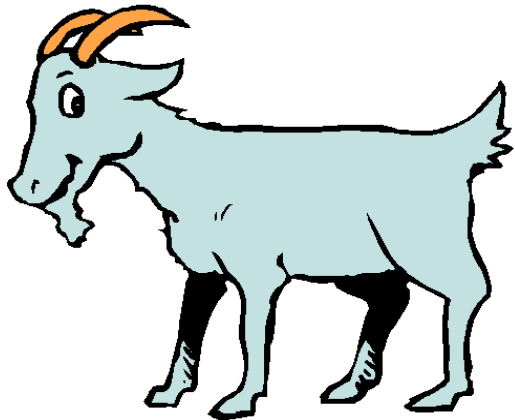
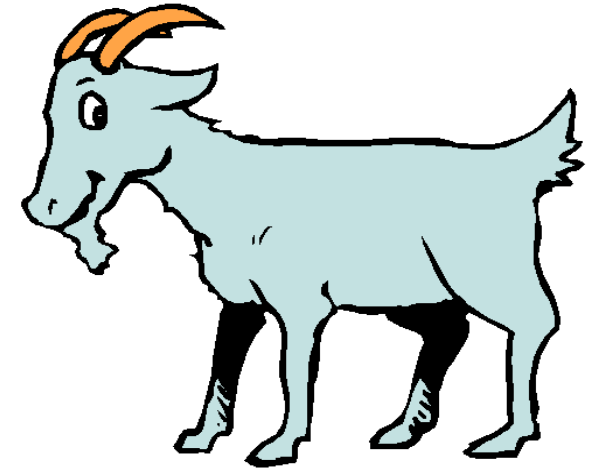

ASSOCIAZIONI DI IMMAGINI UGUALI
Dopo averle denominate far associare le immagini uguali.

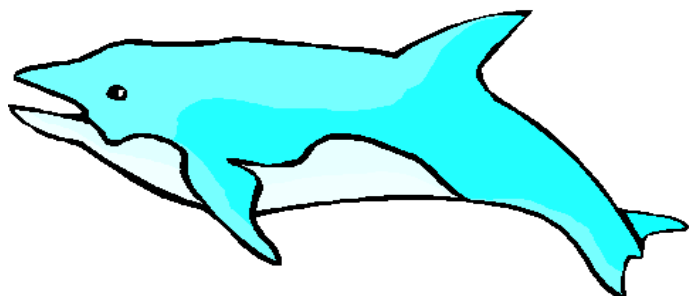
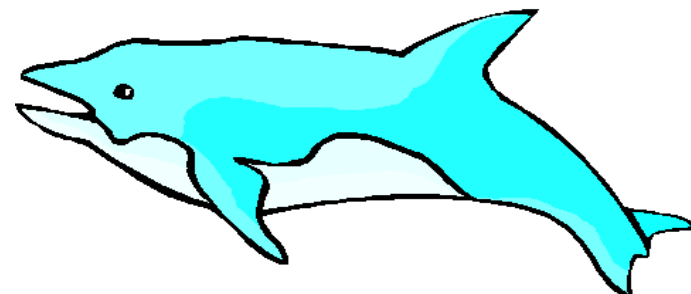

ASSOCIAZIONI DI IMMAGINI UGUALI
Dopo averle denominate far associare le immagini uguali.

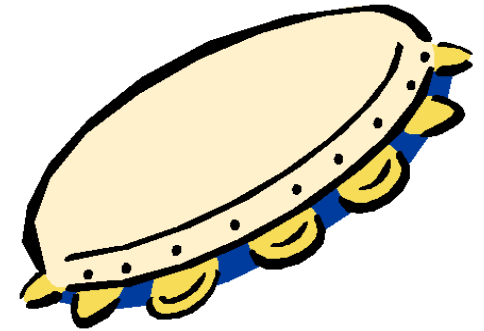
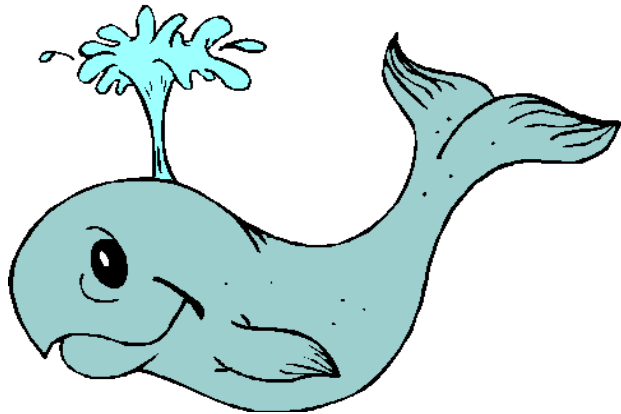
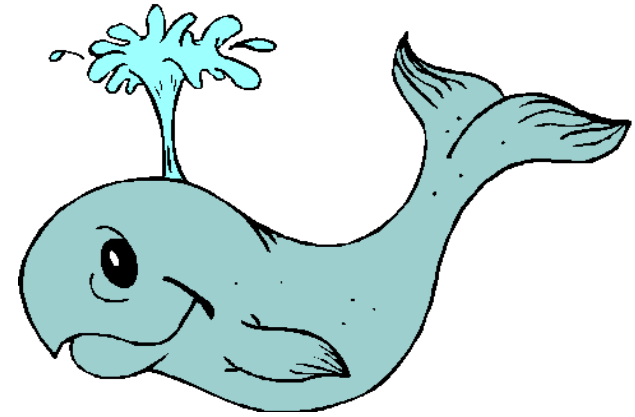
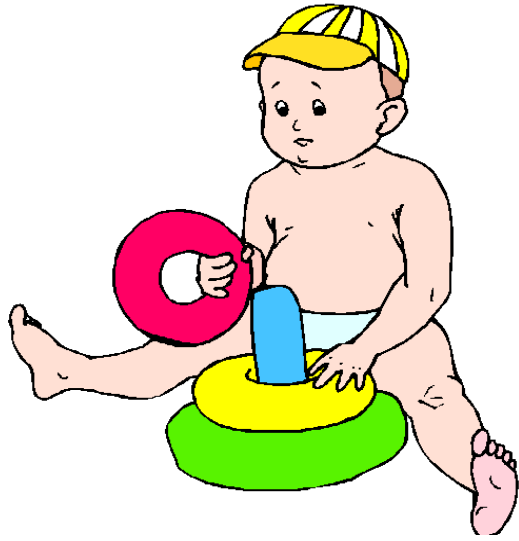

ASSOCIAZIONI DI IMMAGINI UGUALI
Dopo averle denominate far associare le immagini uguali.

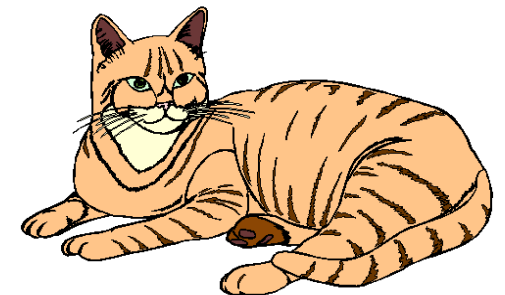
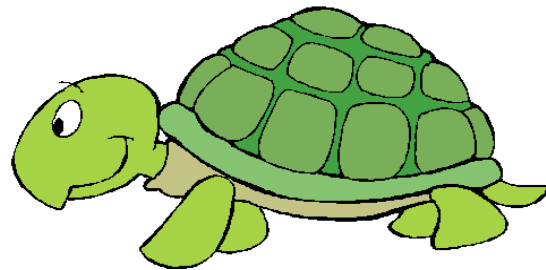
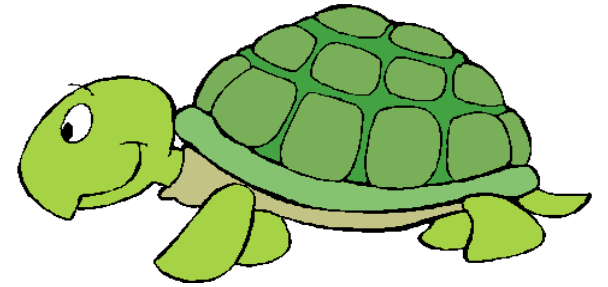
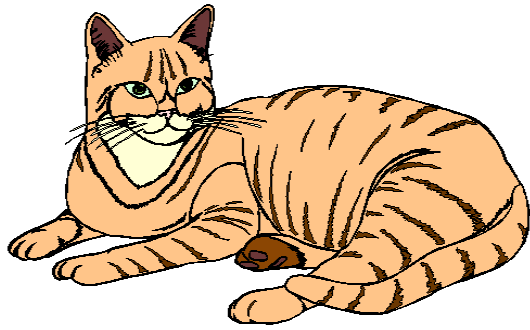

ASSOCIAZIONI DI IMMAGINI UGUALI
Dopo averle denominate far associare le immagini uguali.

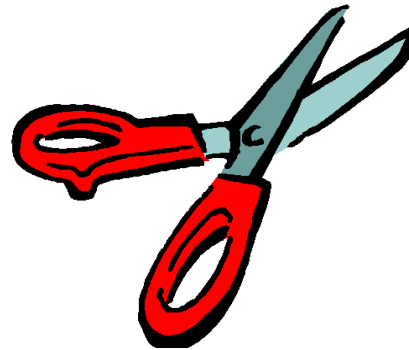
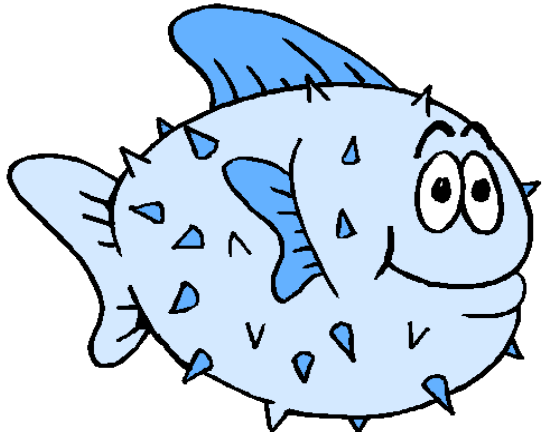
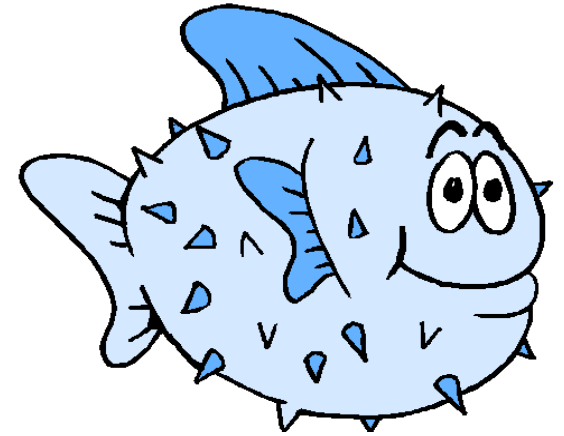

ASSOCIAZIONI DI IMMAGINI UGUALI
Dopo averle denominate far associare le immagini uguali.



ASSOCIAZIONI DI IMMAGINI UGUALI
Dopo averle denominate far associare le immagini uguali.

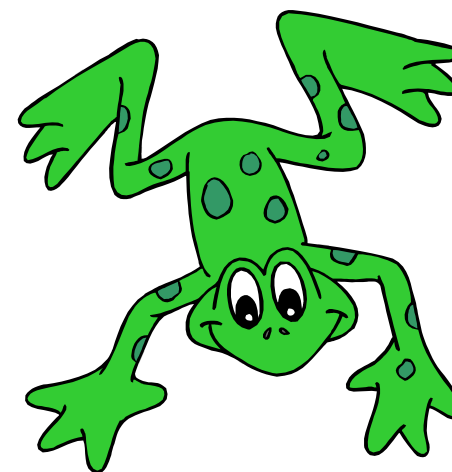
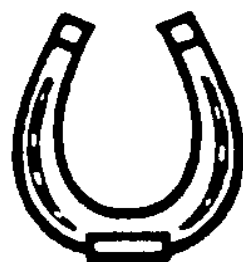
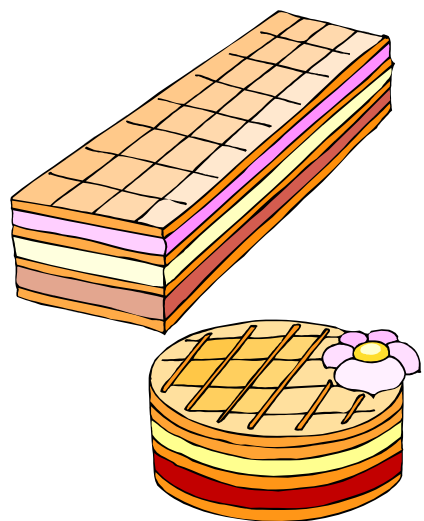
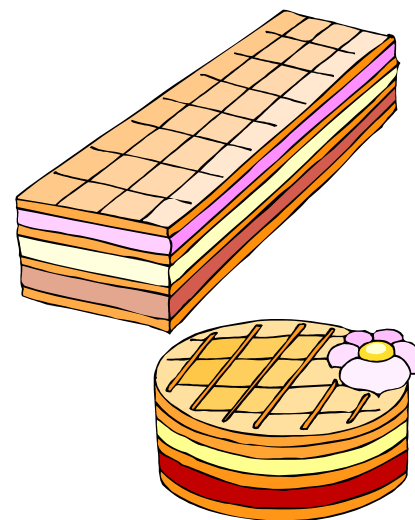
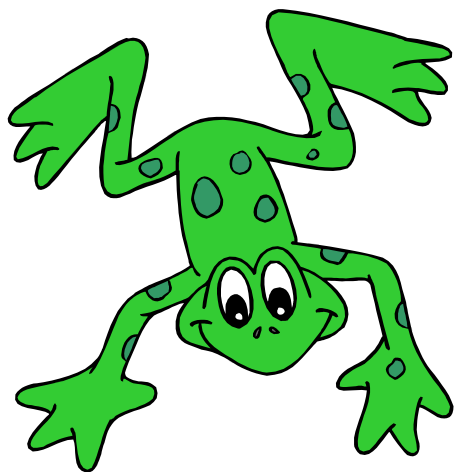

ASSOCIAZIONI DI IMMAGINI UGUALI
Dopo averle denominate far associare le immagini uguali.

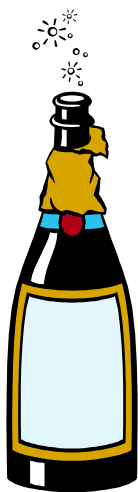
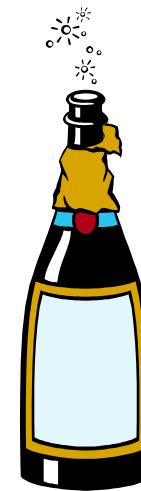

ASSOCIAZIONI DI IMMAGINI UGUALI
Dopo averle denominate far associare le immagini uguali.

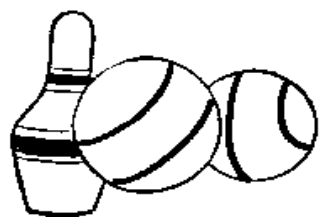

ASSOCIAZIONI DI IMMAGINI UGUALI
Dopo averle denominate far associare le immagini uguali.

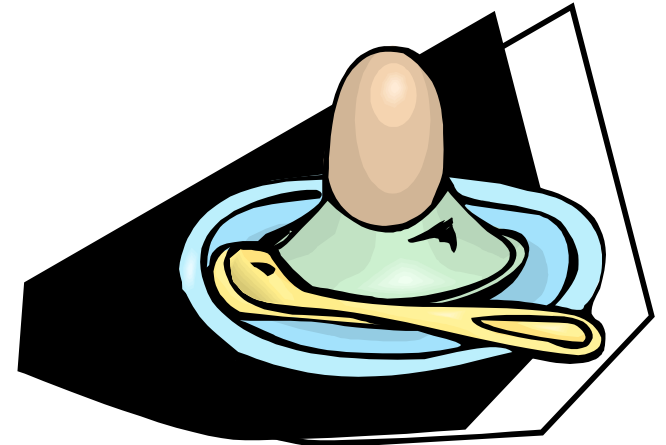
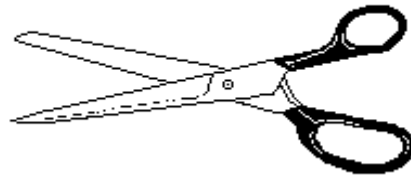
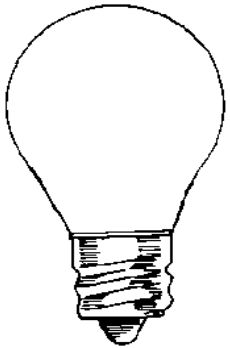
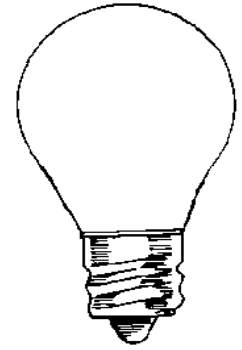
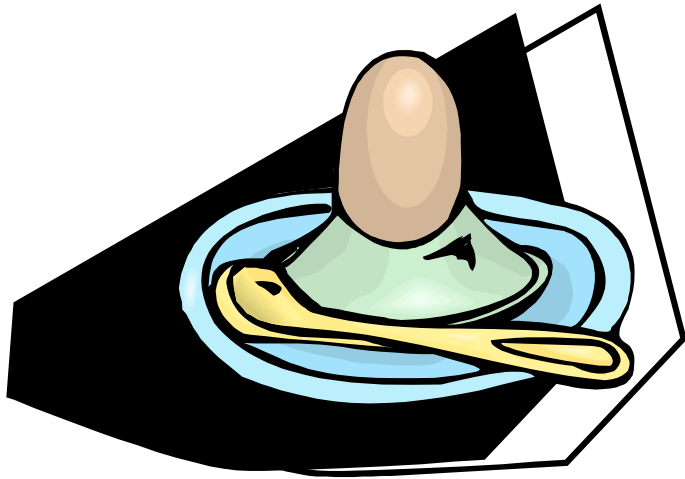

ASSOCIAZIONI DI IMMAGINI UGUALI
Dopo averle denominate far associare le immagini uguali.

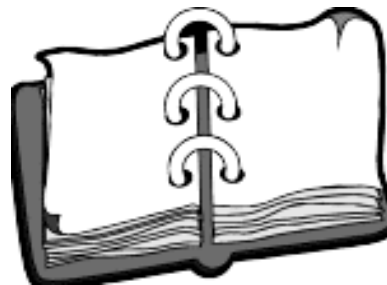
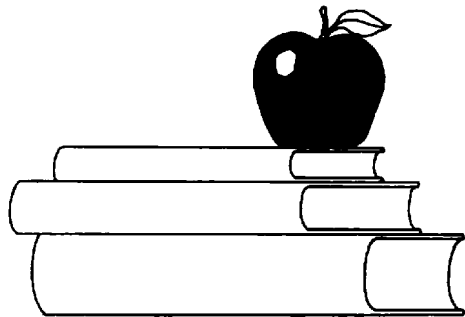
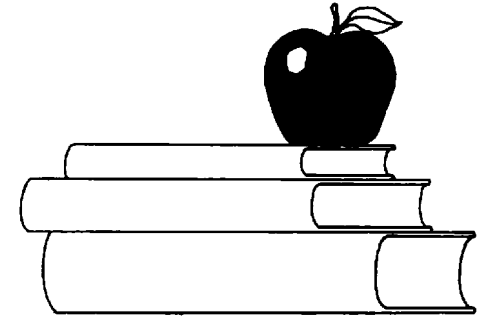

ASSOCIAZIONI DI IMMAGINI UGUALI
Dopo averle denominate far associare le immagini uguali.

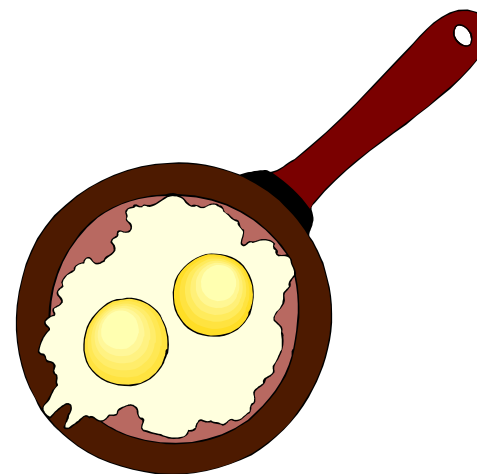
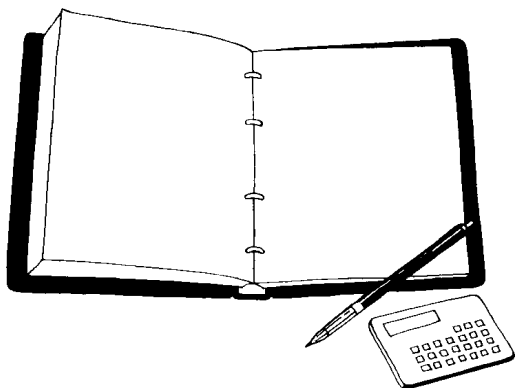
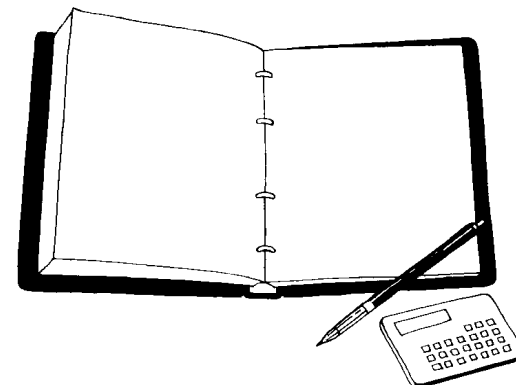
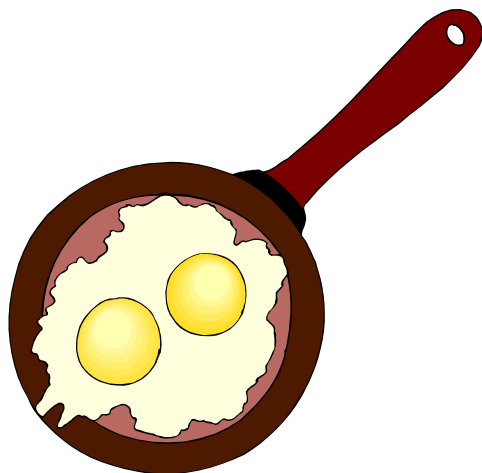

ASSOCIAZIONI DI IMMAGINI UGUALI
Dopo averle denominate far associare le immagini uguali.

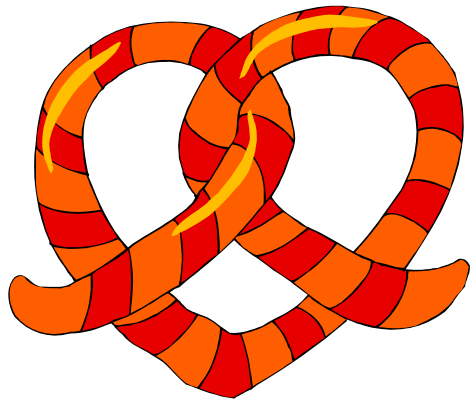
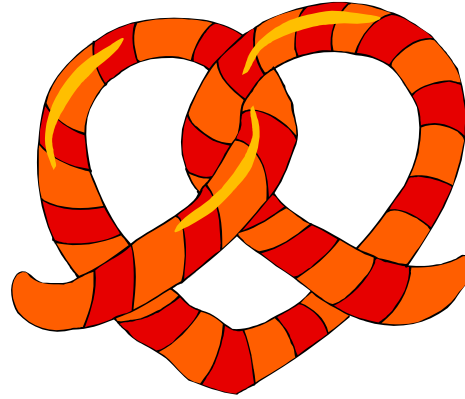

ASSOCIAZIONI DI IMMAGINI UGUALI
Dopo averle denominate far associare le immagini uguali.

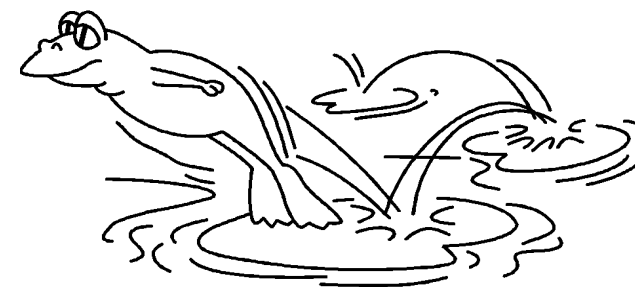
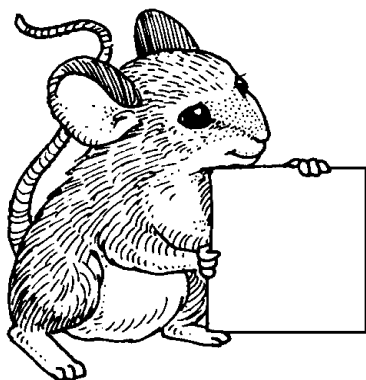
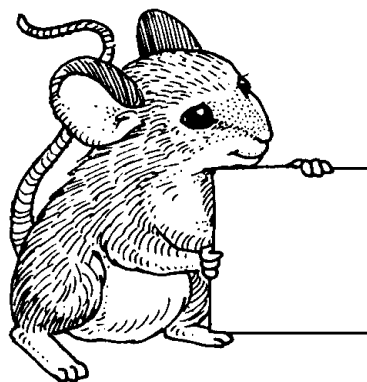
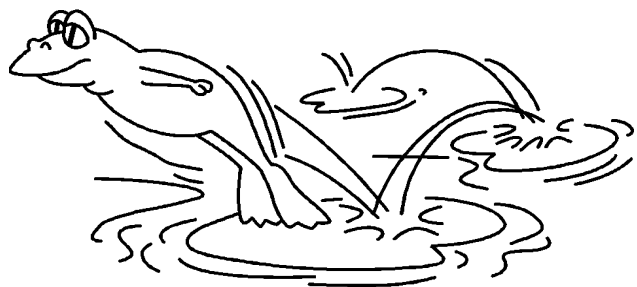

ASSOCIAZIONI DI IMMAGINI UGUALI
Dopo averle denominate far associare le immagini uguali.

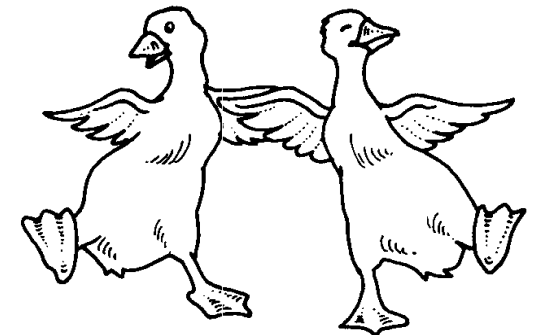
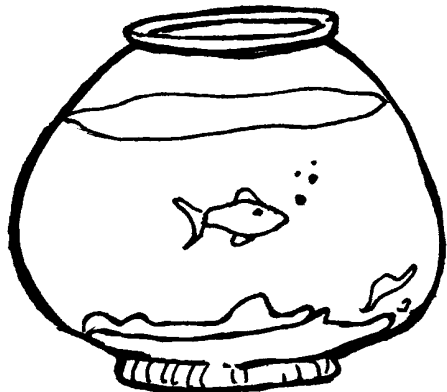
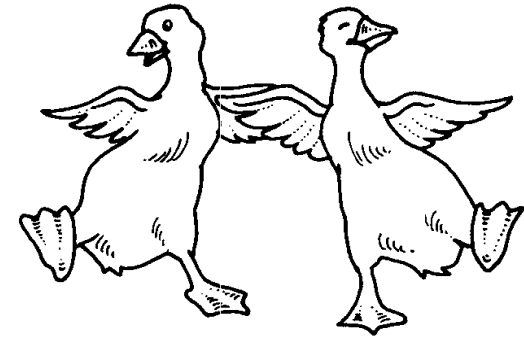
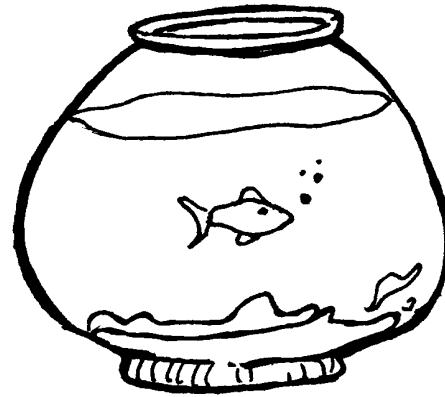
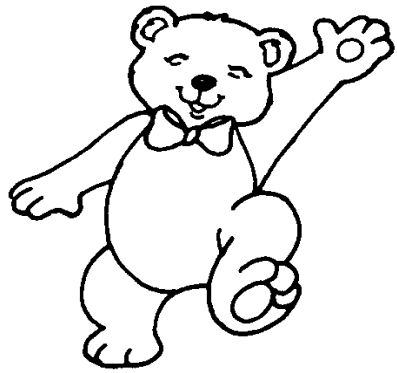

ASSOCIAZIONI DI IMMAGINI UGUALI
Dopo averle denominate far associare le immagini uguali.

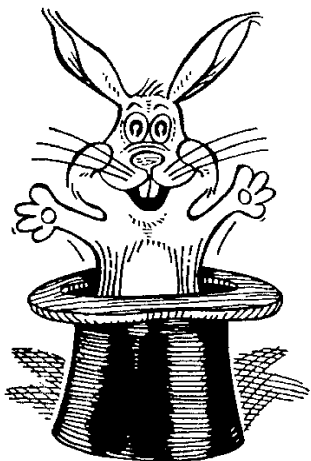
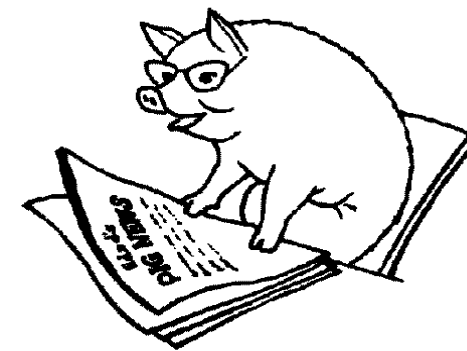
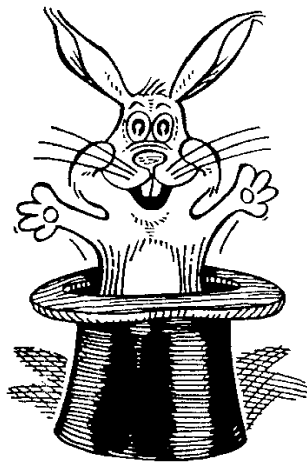

ASSOCIAZIONI DI IMMAGINI UGUALI
Dopo averle denominate far associare le immagini uguali.



ASSOCIAZIONI DI IMMAGINI UGUALI
Dopo averle denominate far associare le immagini uguali.

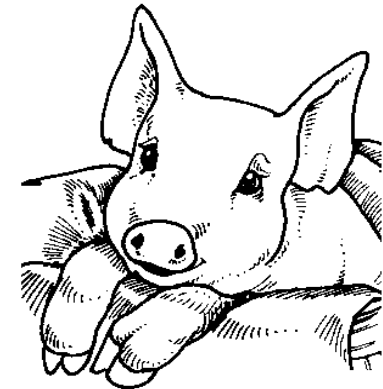
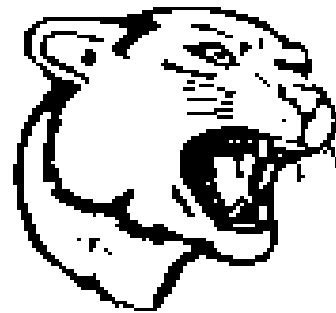
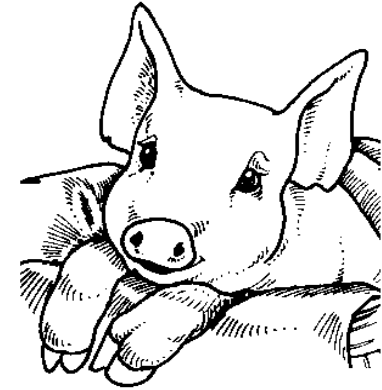

ASSOCIAZIONI DI IMMAGINI UGUALI
Dopo averle denominate far associare le immagini uguali.

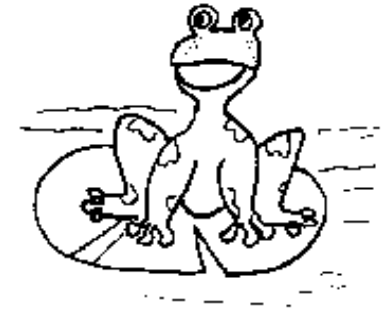

ASSOCIAZIONI DI IMMAGINI UGUALI
Dopo averle denominate far associare le immagini uguali.

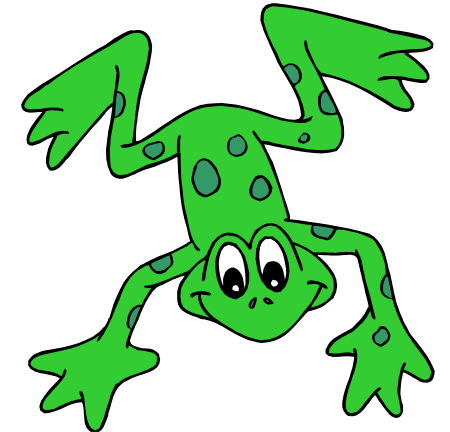
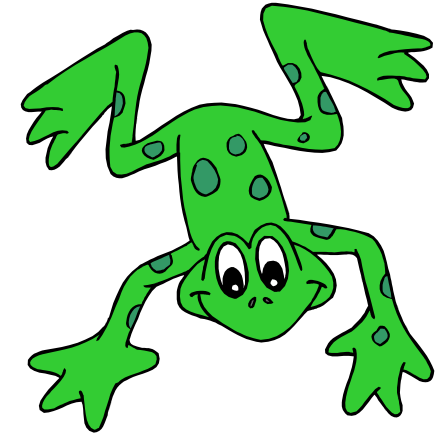

ASSOCIAZIONI DI IMMAGINI UGUALI
Dopo averle denominate far associare le immagini uguali.

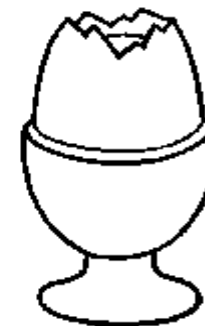
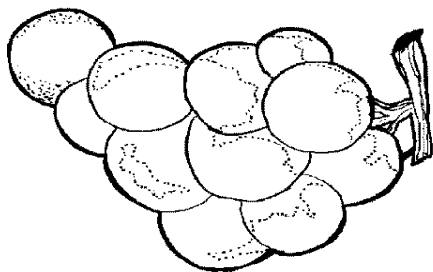
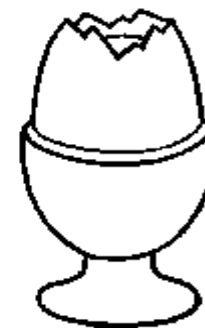
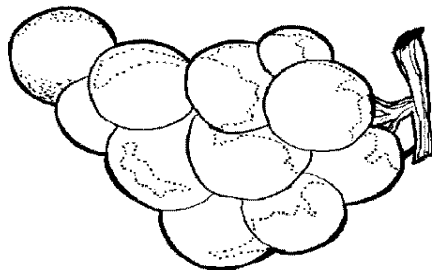

ASSOCIAZIONI DI IMMAGINI UGUALI
Dopo averle denominate far associare le immagini uguali.

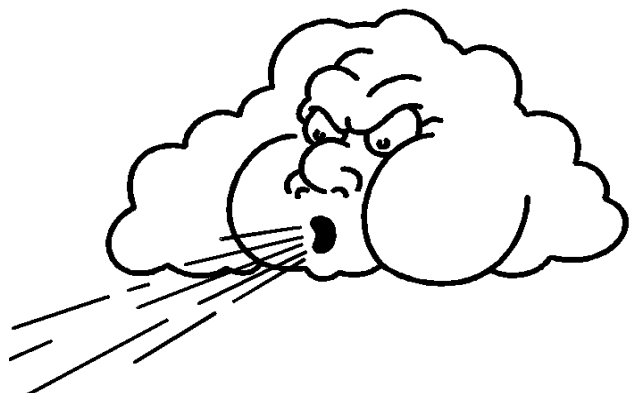

ASSOCIAZIONI DI IMMAGINI UGUALI
Dopo averle denominate far associare le immagini uguali.

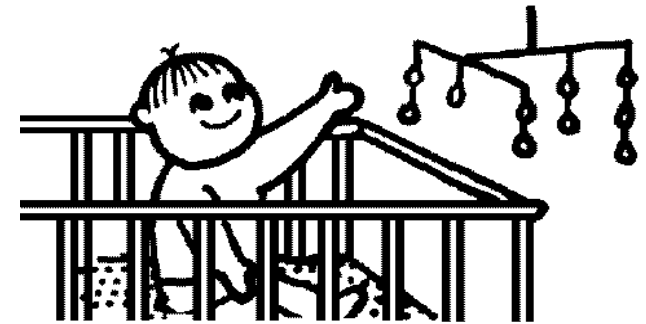
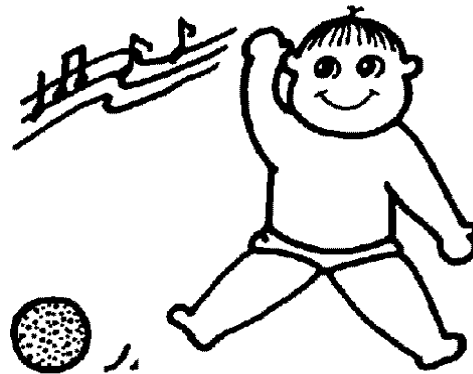
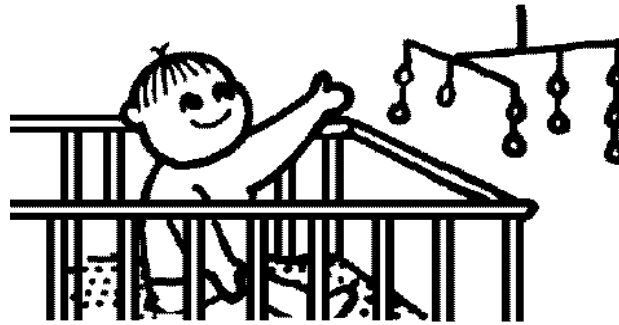

ASSOCIAZIONI DI IMMAGINI UGUALI
Dopo averle denominate far associare le immagini uguali.

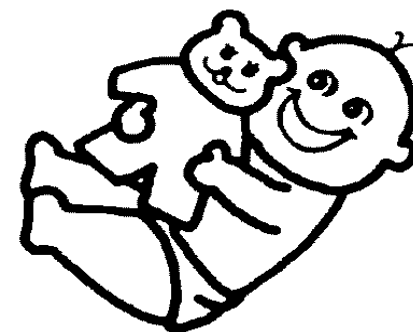
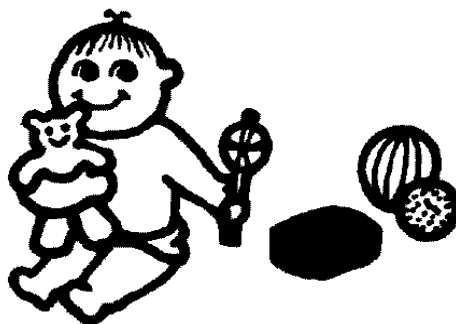
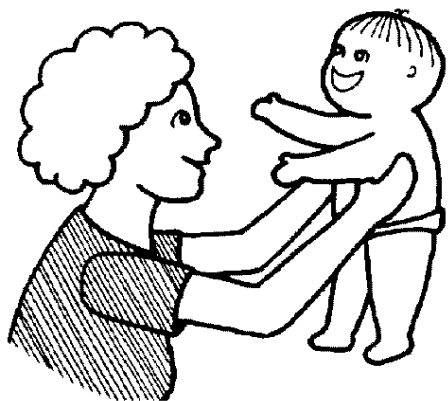
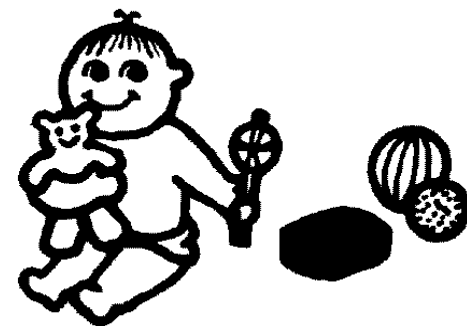
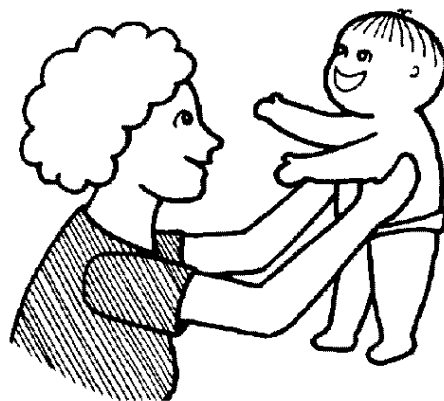
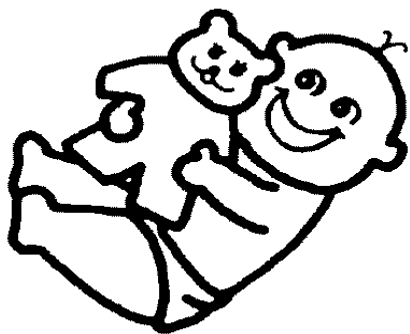

ASSOCIAZIONI DI IMMAGINI UGUALI
Dopo averle denominate far associare le immagini uguali.

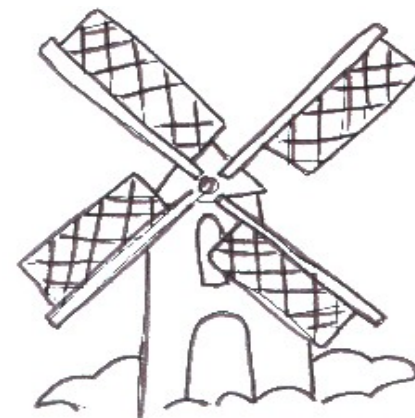
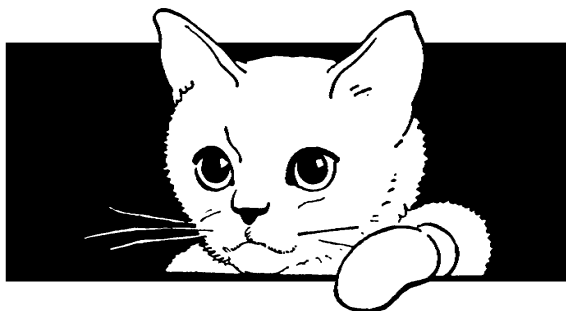
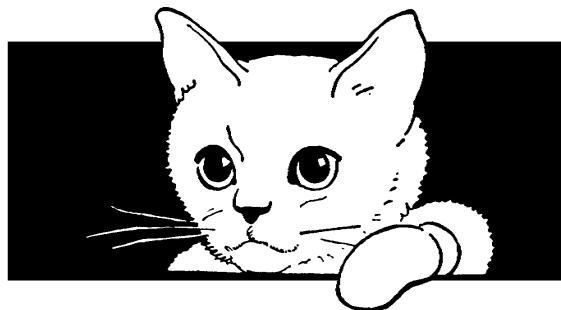
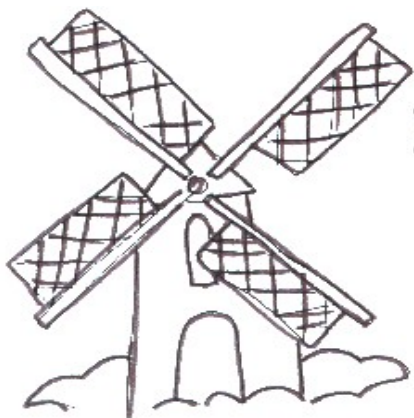

ASSOCIAZIONI DI IMMAGINI UGUALI
Dopo averle denominate far associare le immagini uguali.

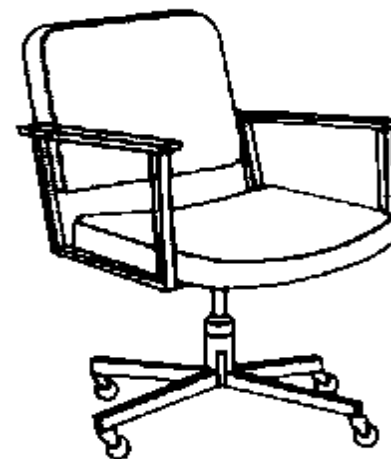
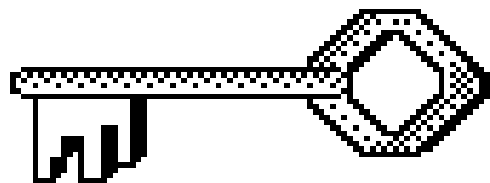
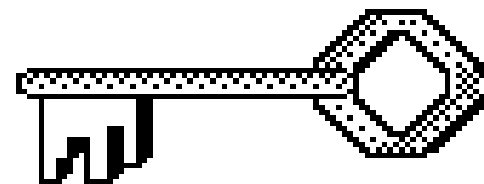
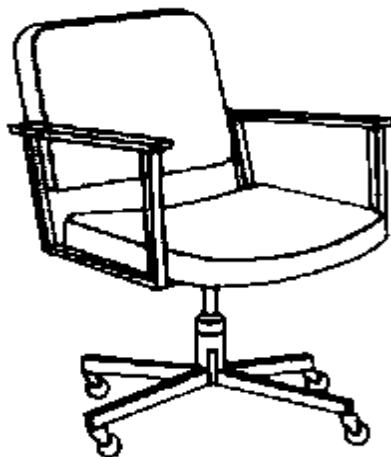

ASSOCIAZIONI DI IMMAGINI UGUALI
Dopo averle denominate far associare le immagini uguali.

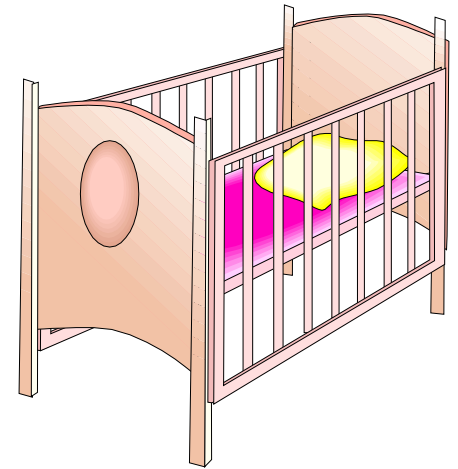
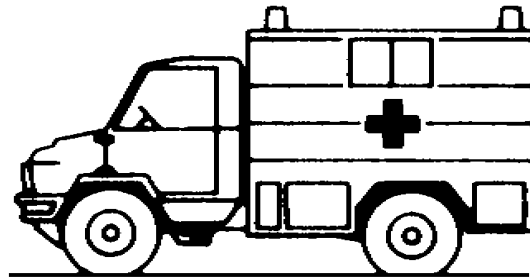
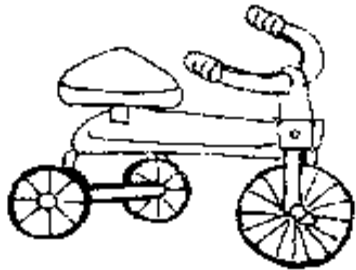
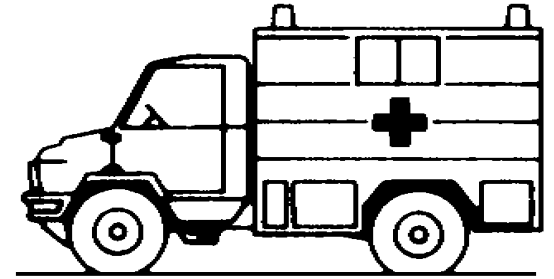
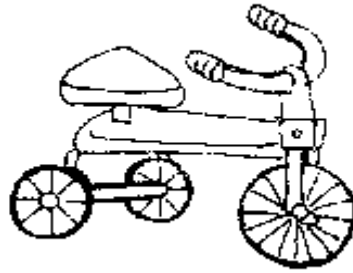
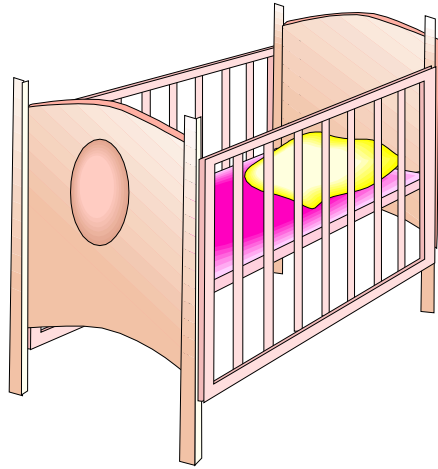

ASSOCIAZIONI DI IMMAGINI UGUALI
Dopo averle denominate far associare le immagini uguali.

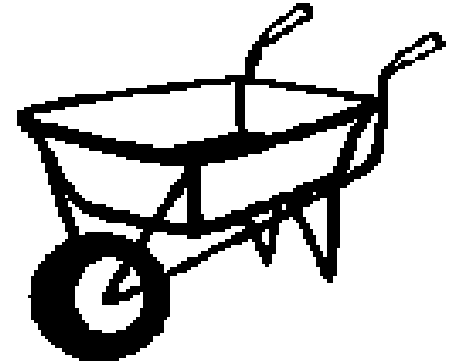
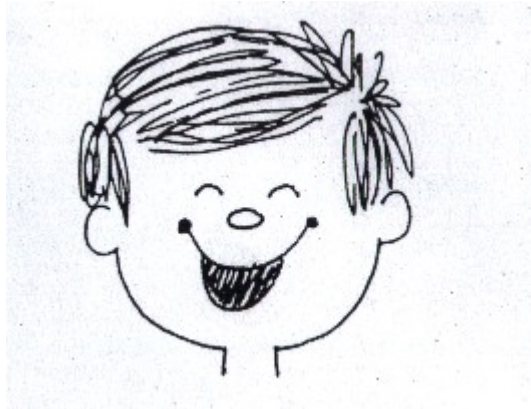
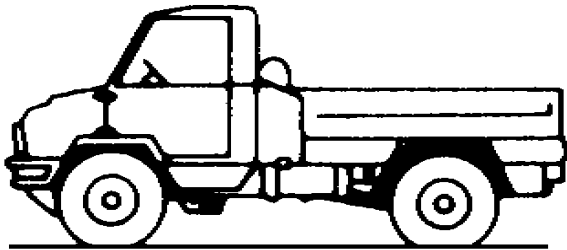
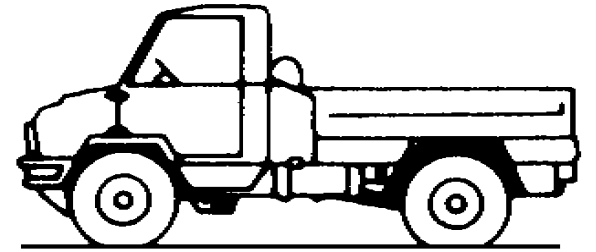
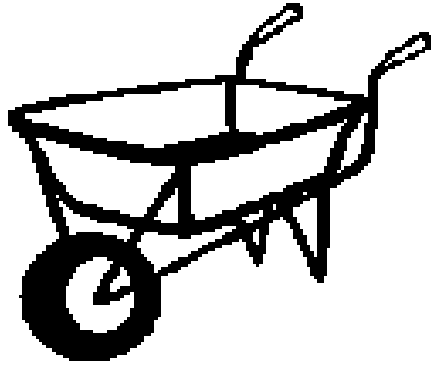
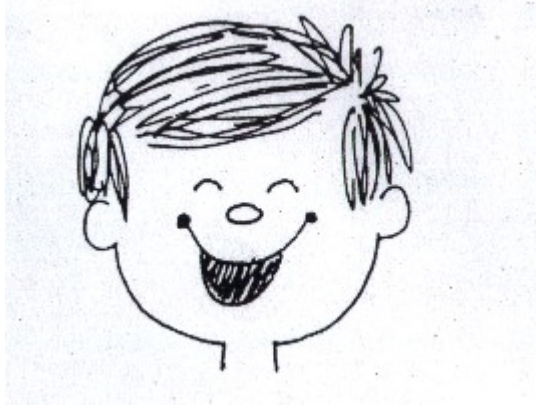

ASSOCIAZIONI DI IMMAGINI UGUALI
Dopo averle denominate far associare le immagini uguali.

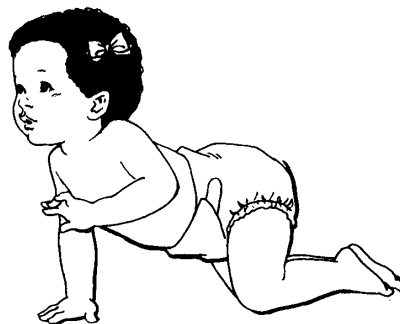
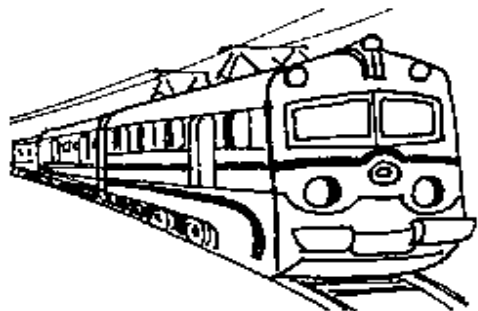
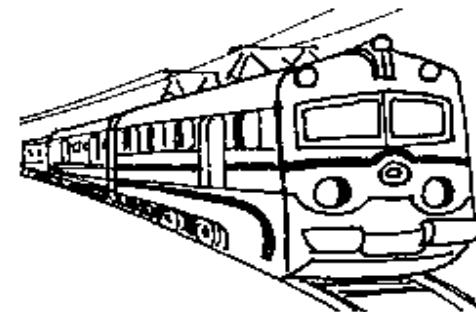
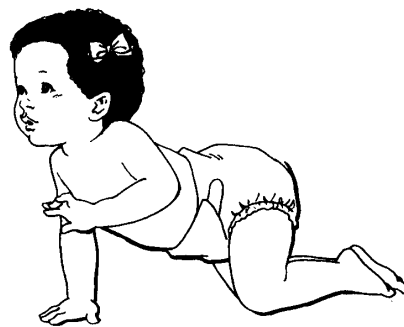

ASSOCIAZIONI DI IMMAGINI UGUALI
Dopo averle denominate far associare le immagini uguali.

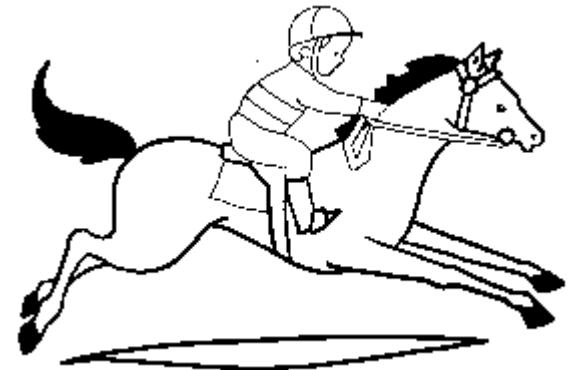
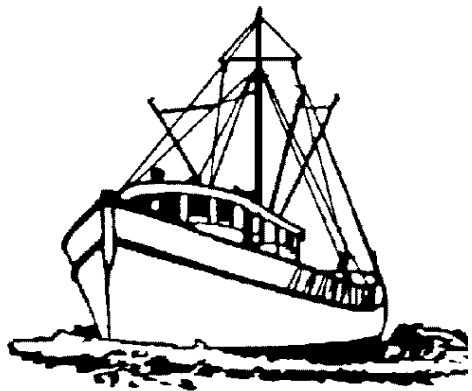
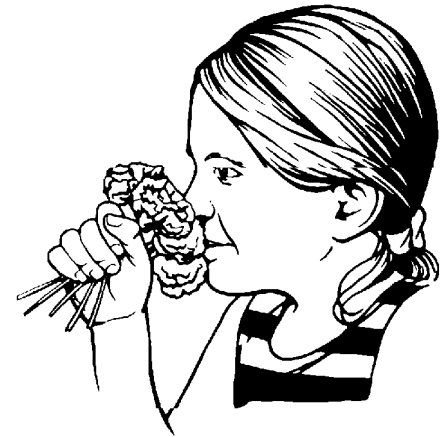
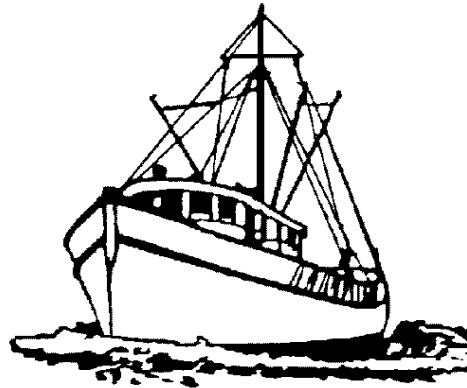
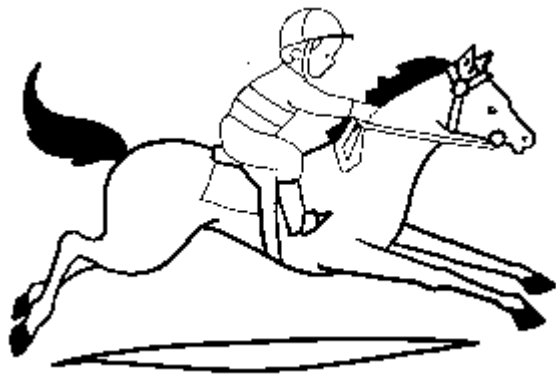

ASSOCIAZIONI DI IMMAGINI UGUALI
Dopo averle denominate far associare le immagini uguali.

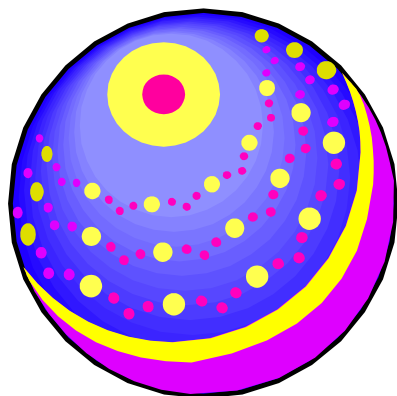
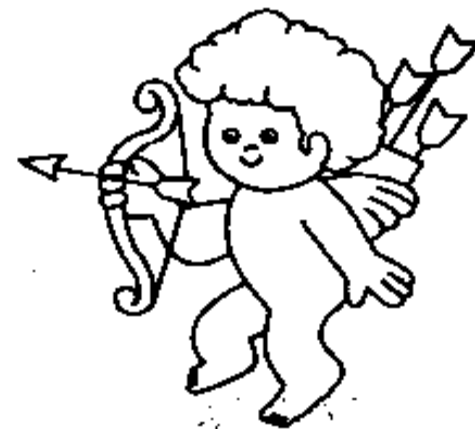
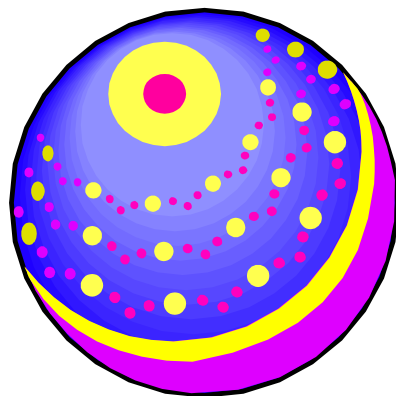

ASSOCIAZIONI DI IMMAGINI UGUALI
Dopo averle denominate far associare le immagini uguali.

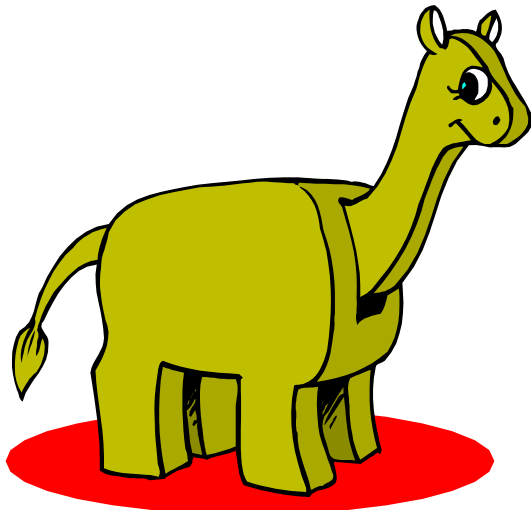
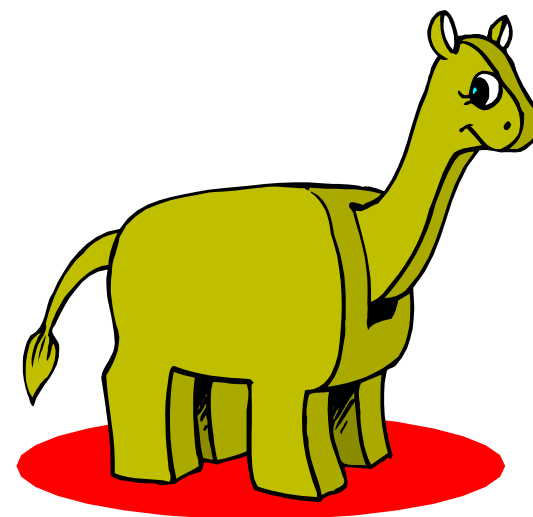

ASSOCIAZIONI DI IMMAGINI UGUALI
Dopo averle denominate far associare le immagini uguali.

“ VOGLIA DI CRESCERE ”

PROGRAMMA BASE PER LO SVILUPPO LOGICO E COGNITIVO

I PERCORSI

I PERCORSI

Il percorrere con il dito una linea che inizialmente è quasi dritta e poi si curva e si piega, comporta uno stimolo notevole alla maturazione di varie funzioni come l'orientamento nello spazio, la coordinazione occhio - mano e il pregrafismo.

UTILIZZAZIONE

Per raggiungere tali obiettivi il tracciato va effettuato seguendo correttamente la linea in tutte le sue evoluzioni con il dito. Per abituare il bambino a controllare in maniera valida i suoi movimenti possiamo inizialmente aiutarlo con la guida manuale o mettendo il nostro dito davanti al suo lungo tutto il percorso.

ETÀ MENTALE DI RIFERIMENTO

Due anni.

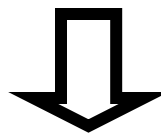

I PERCORSI

Segui con il dito il percorso partendo dalla freccia.

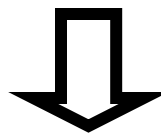

I PERCORSI

Segui con il dito il percorso partendo dalla freccia.

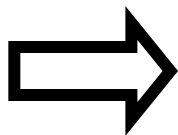
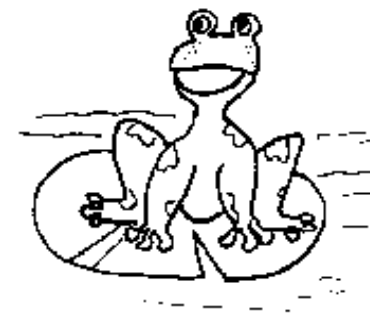

I PERCORSI

Segui con il dito il percorso partendo dalla freccia.

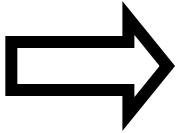

I PERCORSI

Segui con il dito il percorso partendo dalla freccia.

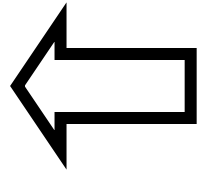

I PERCORSI

Segui con il dito il percorso partendo dalla freccia.

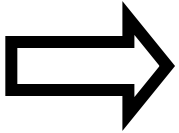

I PERCORSI

Segui con il dito il percorso partendo dalla freccia.

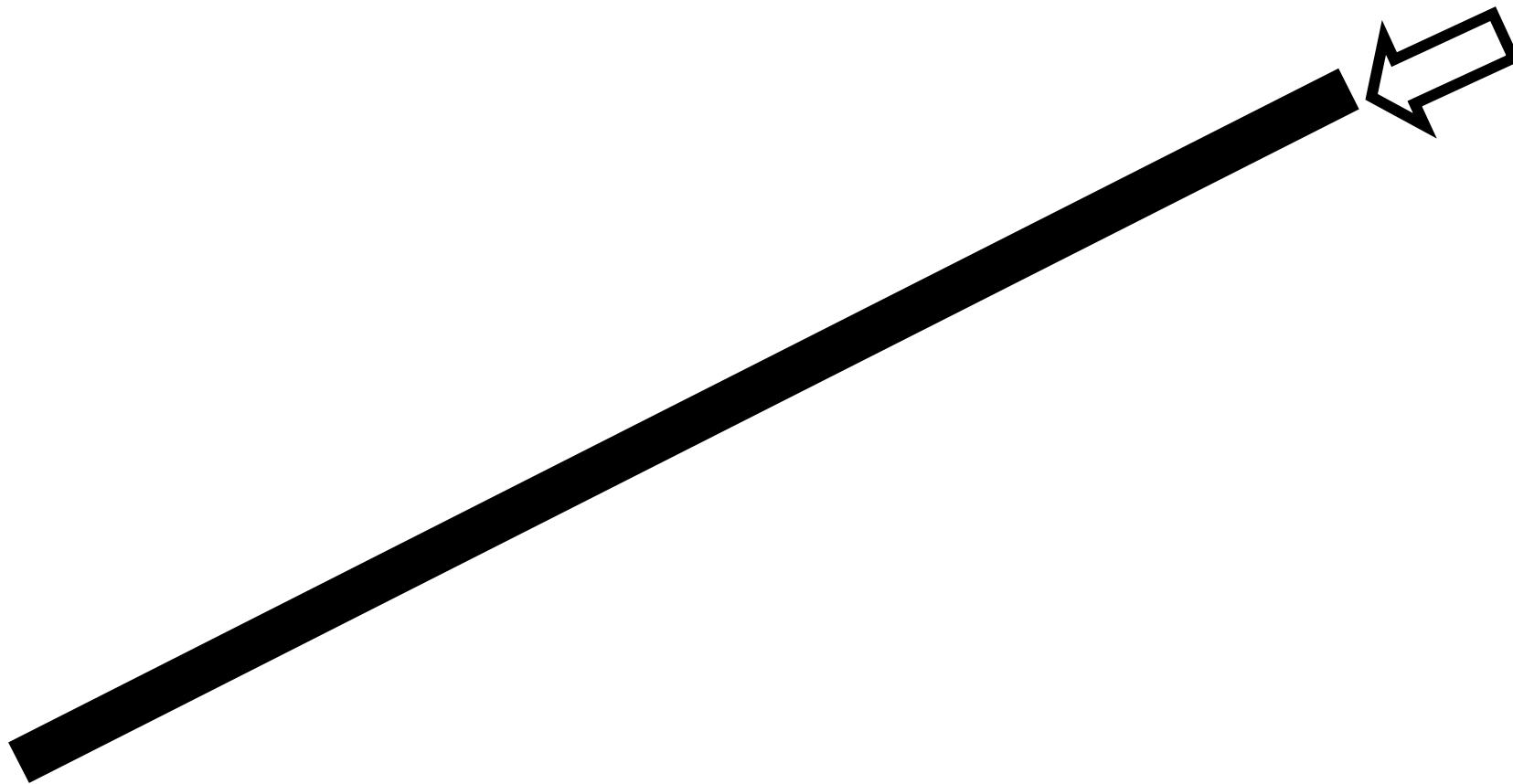

I PERCORSI

Segui con il dito il percorso partendo dalla freccia.

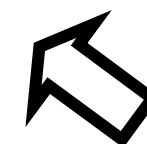
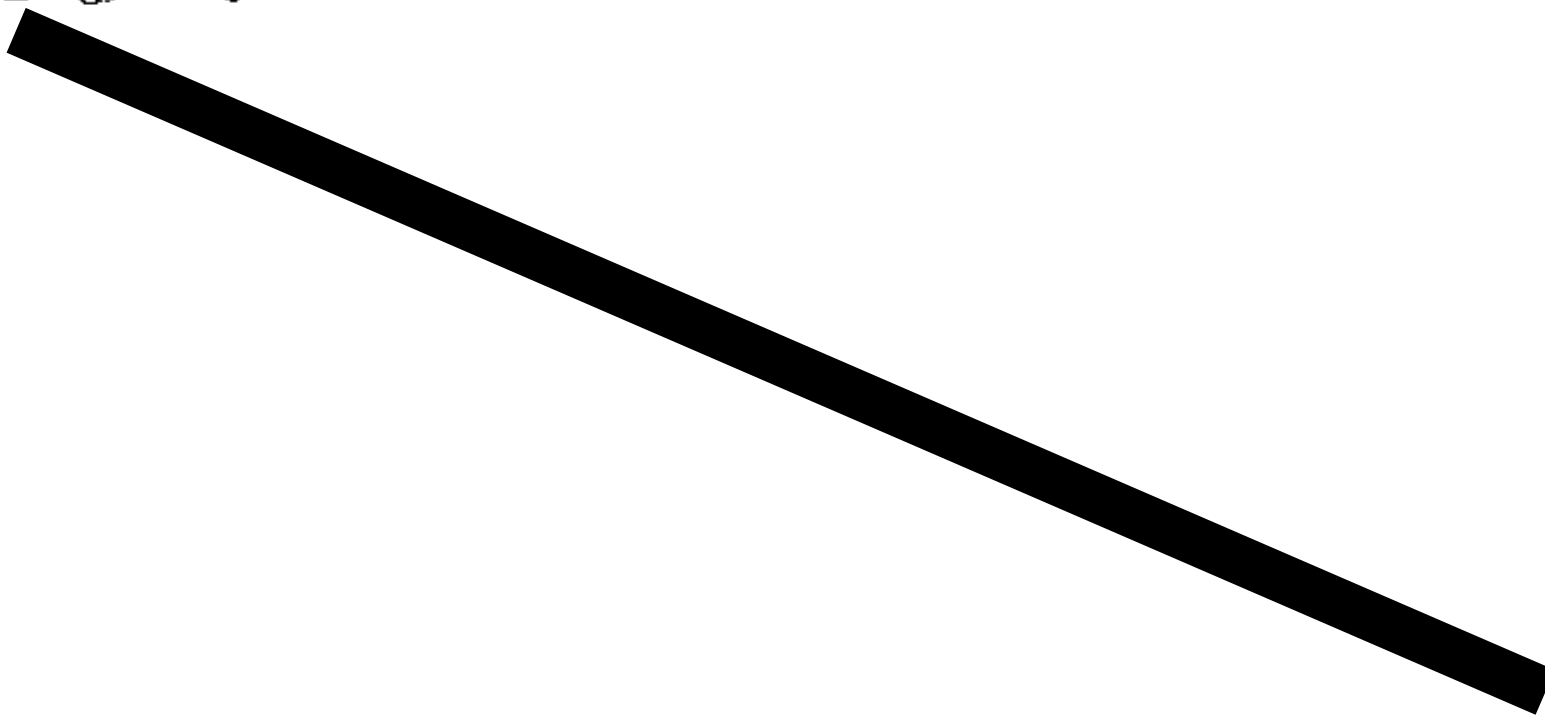

I PERCORSI

Segui con il dito il percorso partendo dalla freccia.

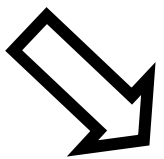

I PERCORSI

Segui con il dito il percorso partendo dalla freccia.

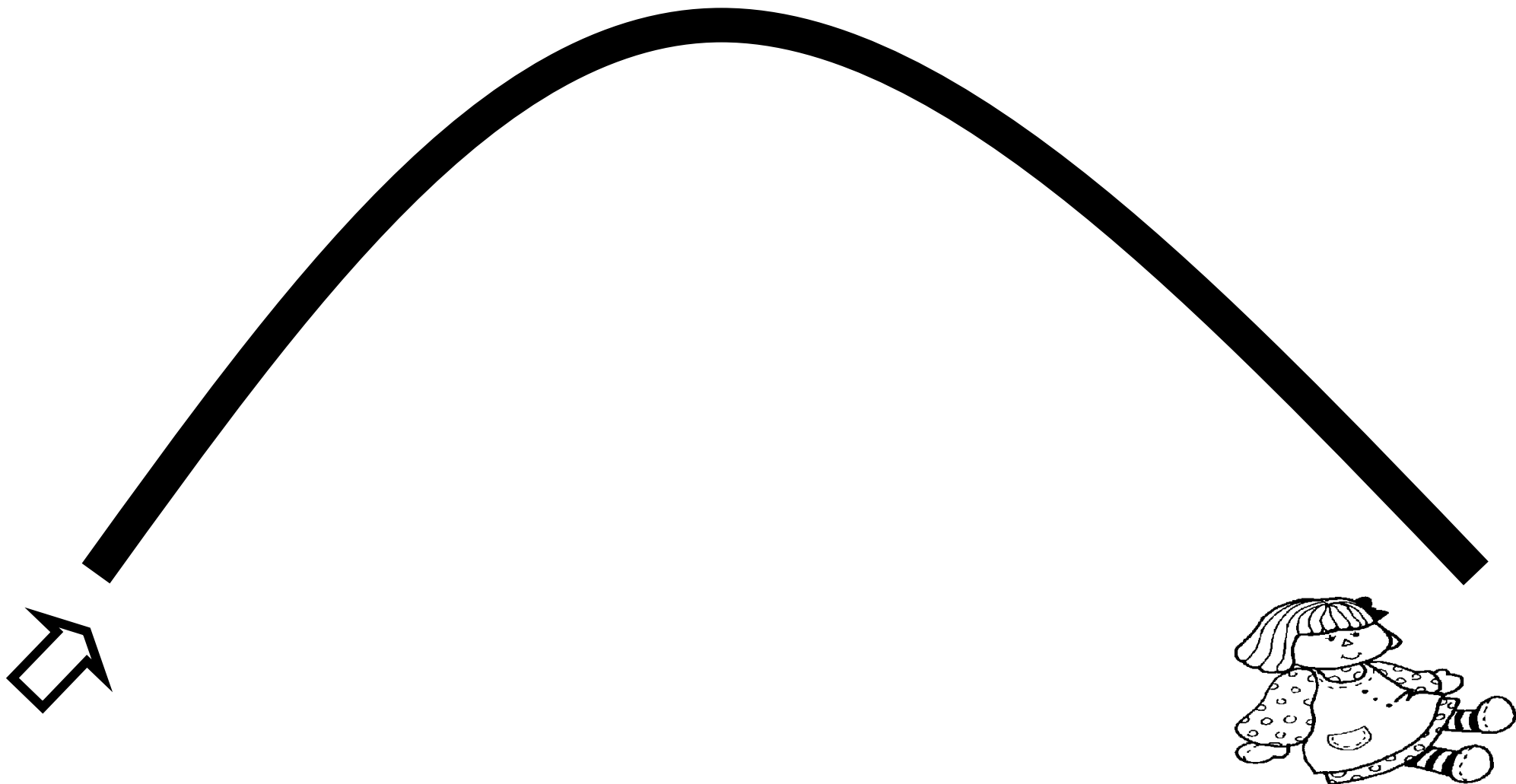

I PERCORSI

Segui con il dito il percorso partendo dalla freccia.

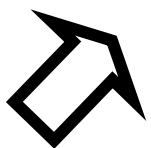
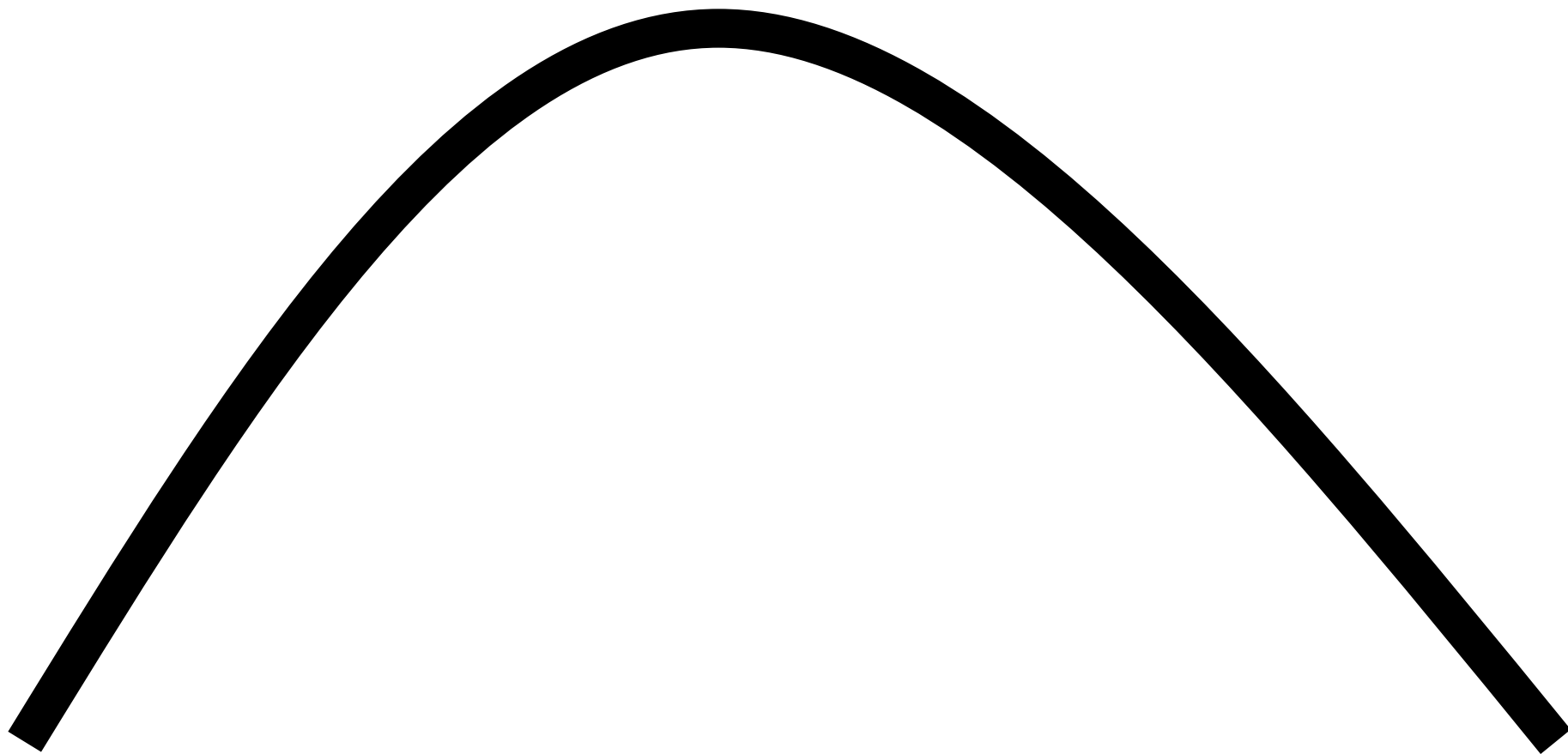

I PERCORSI

Segui con il dito il percorso partendo dalla freccia.

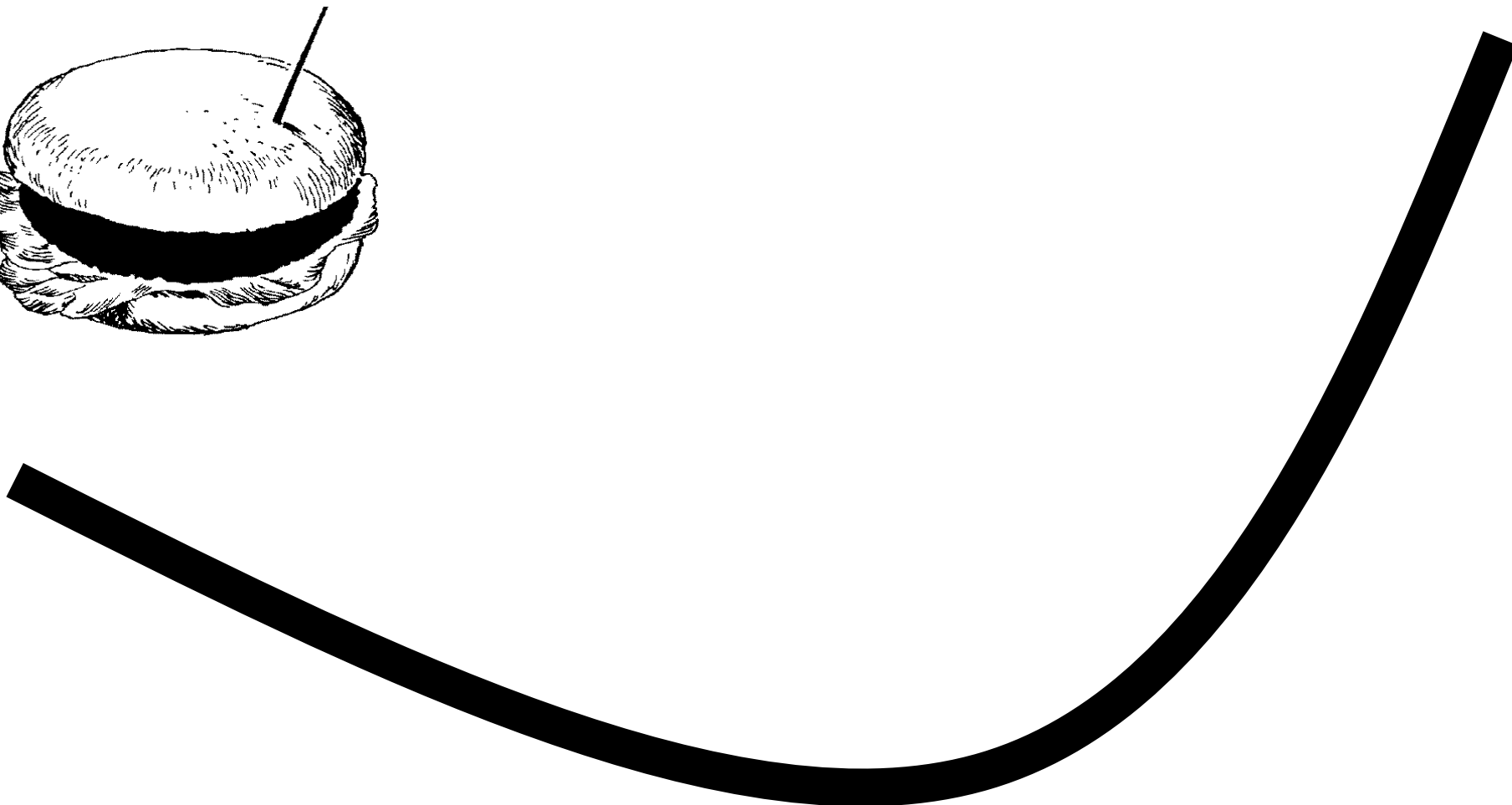
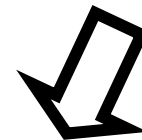
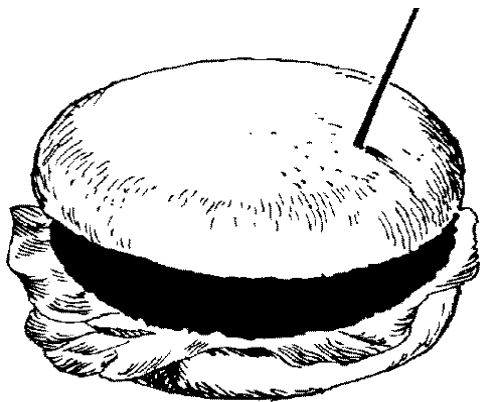

I PERCORSI

Segui con il dito il percorso partendo dalla freccia.

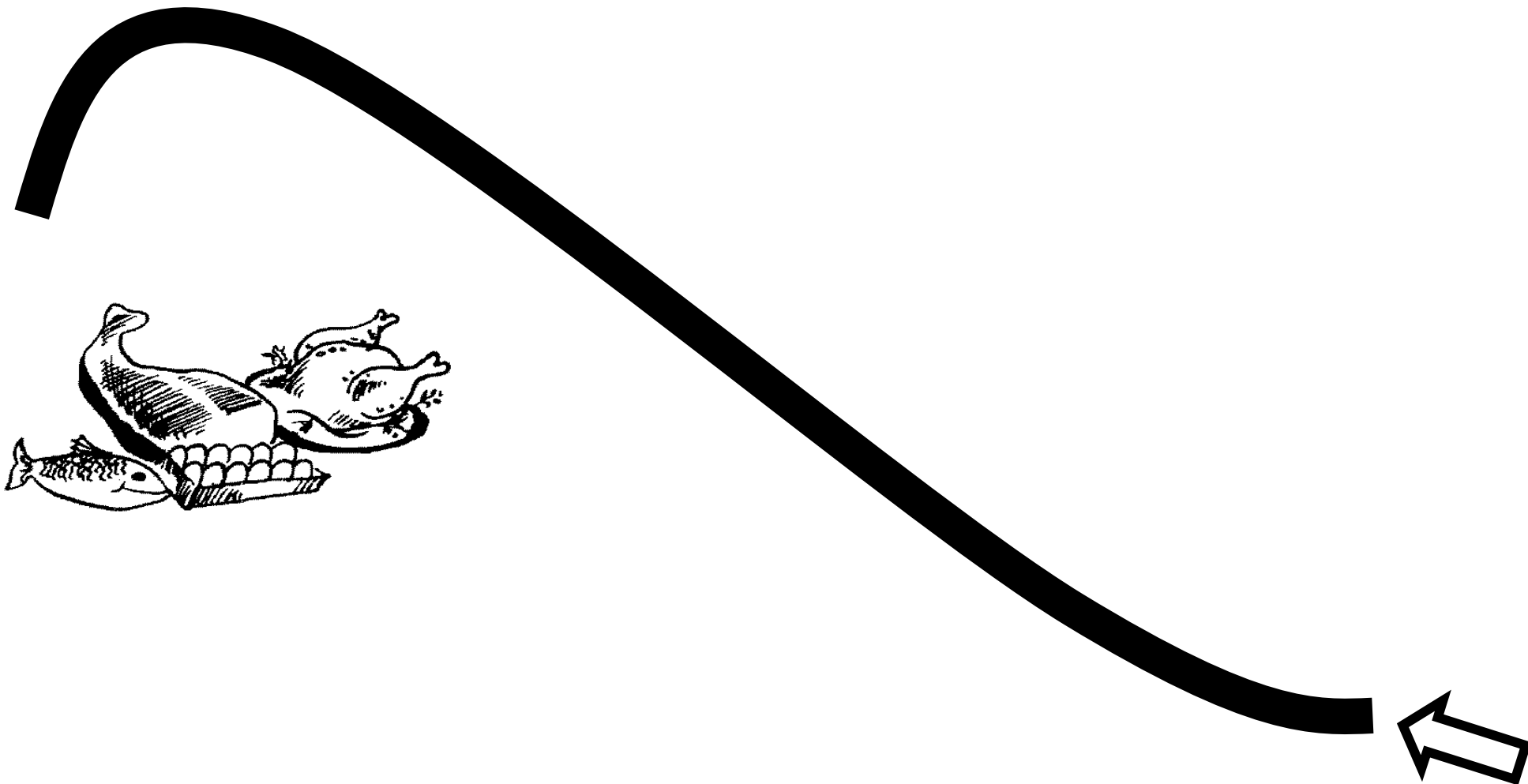

I PERCORSI

Segui con il dito il percorso partendo dalla freccia.

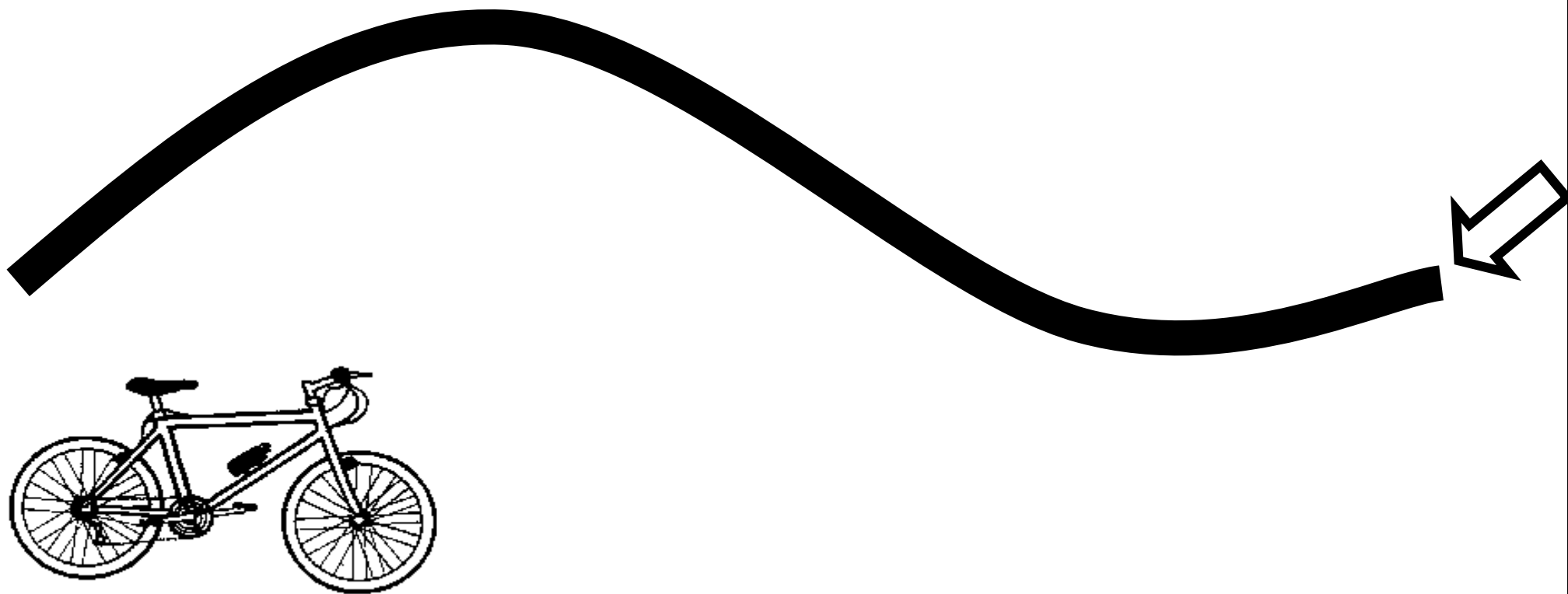

I PERCORSI

Segui con il dito il percorso partendo dalla freccia.

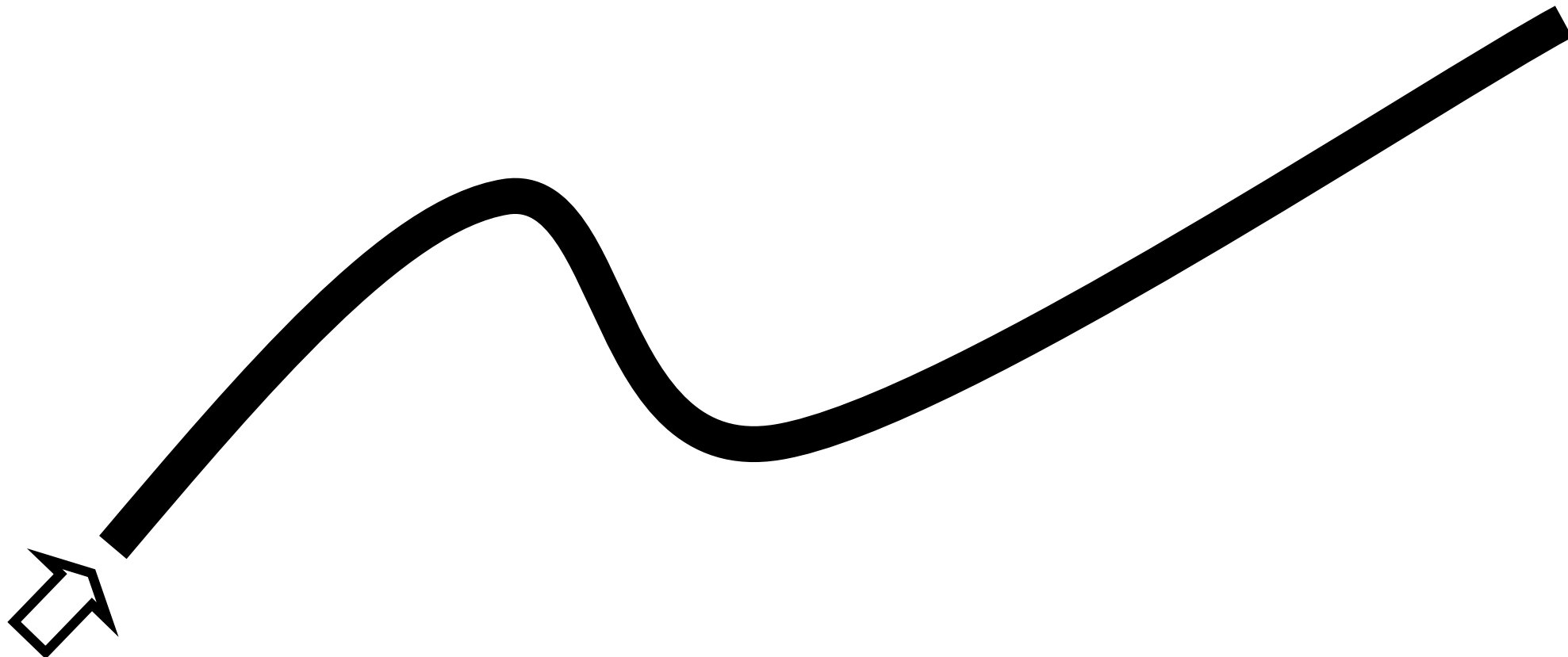

I PERCORSI

Segui con il dito il percorso partendo dalla freccia.

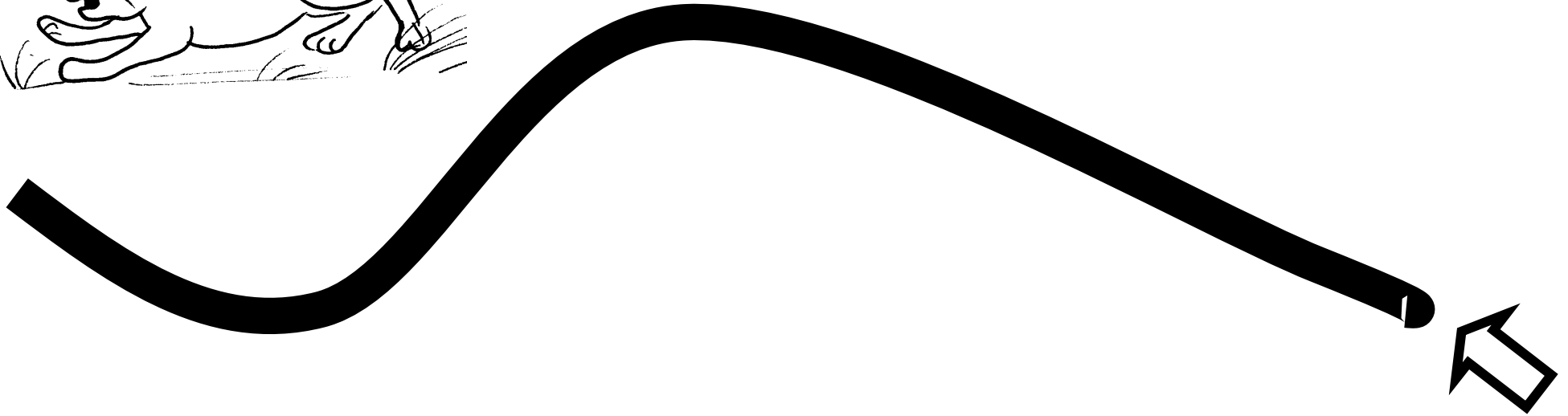
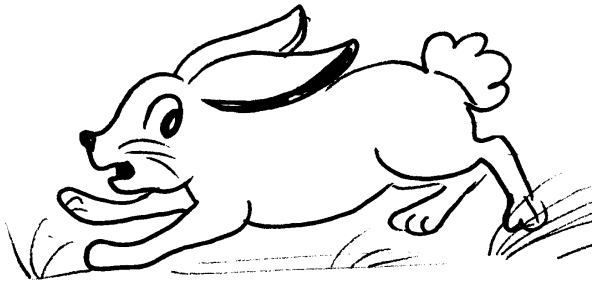

I PERCORSI

Segui con il dito il percorso partendo dalla freccia.

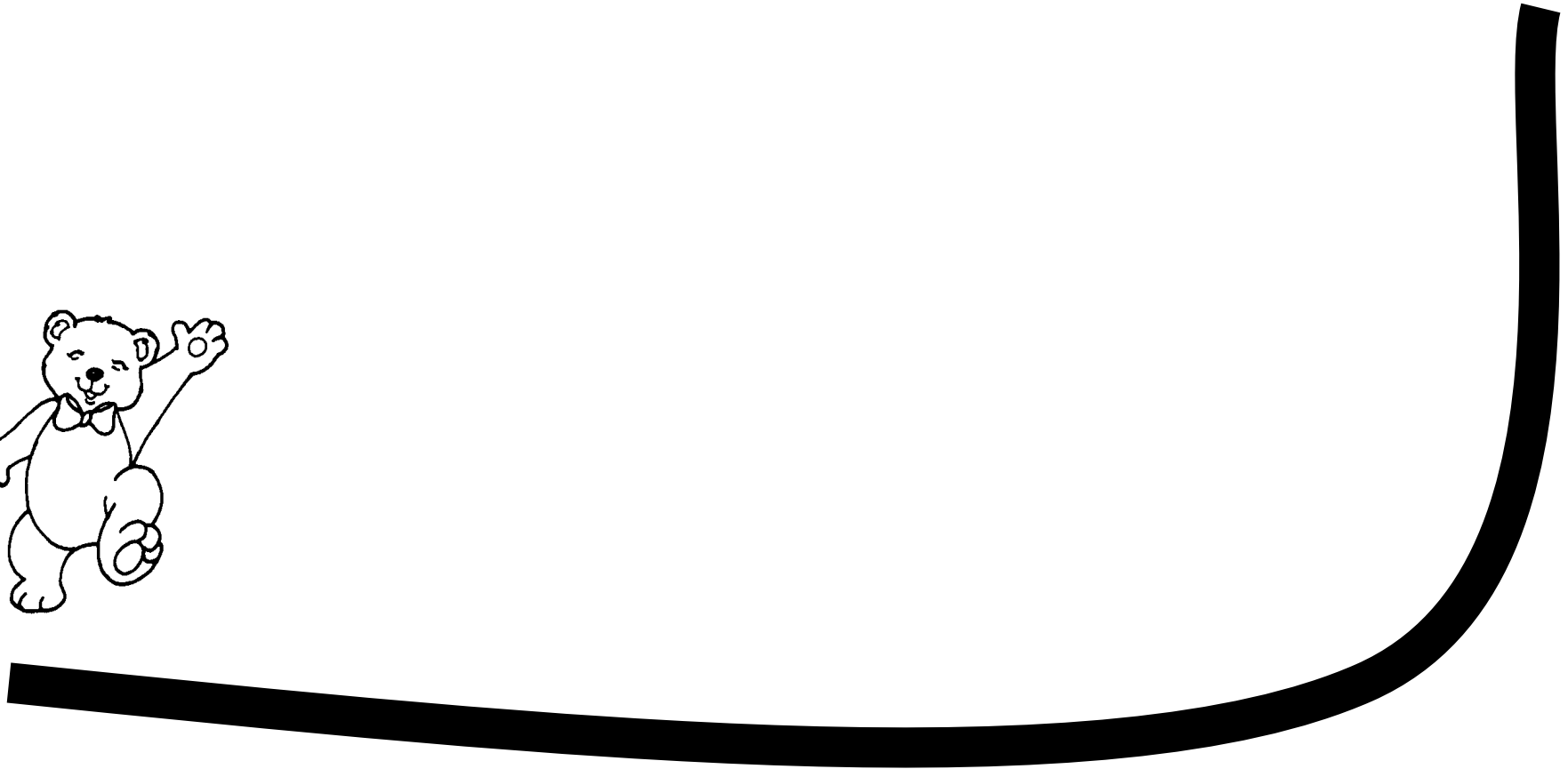
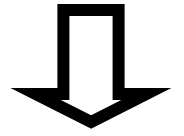

I PERCORSI

Segui con il dito il percorso partendo dalla freccia.

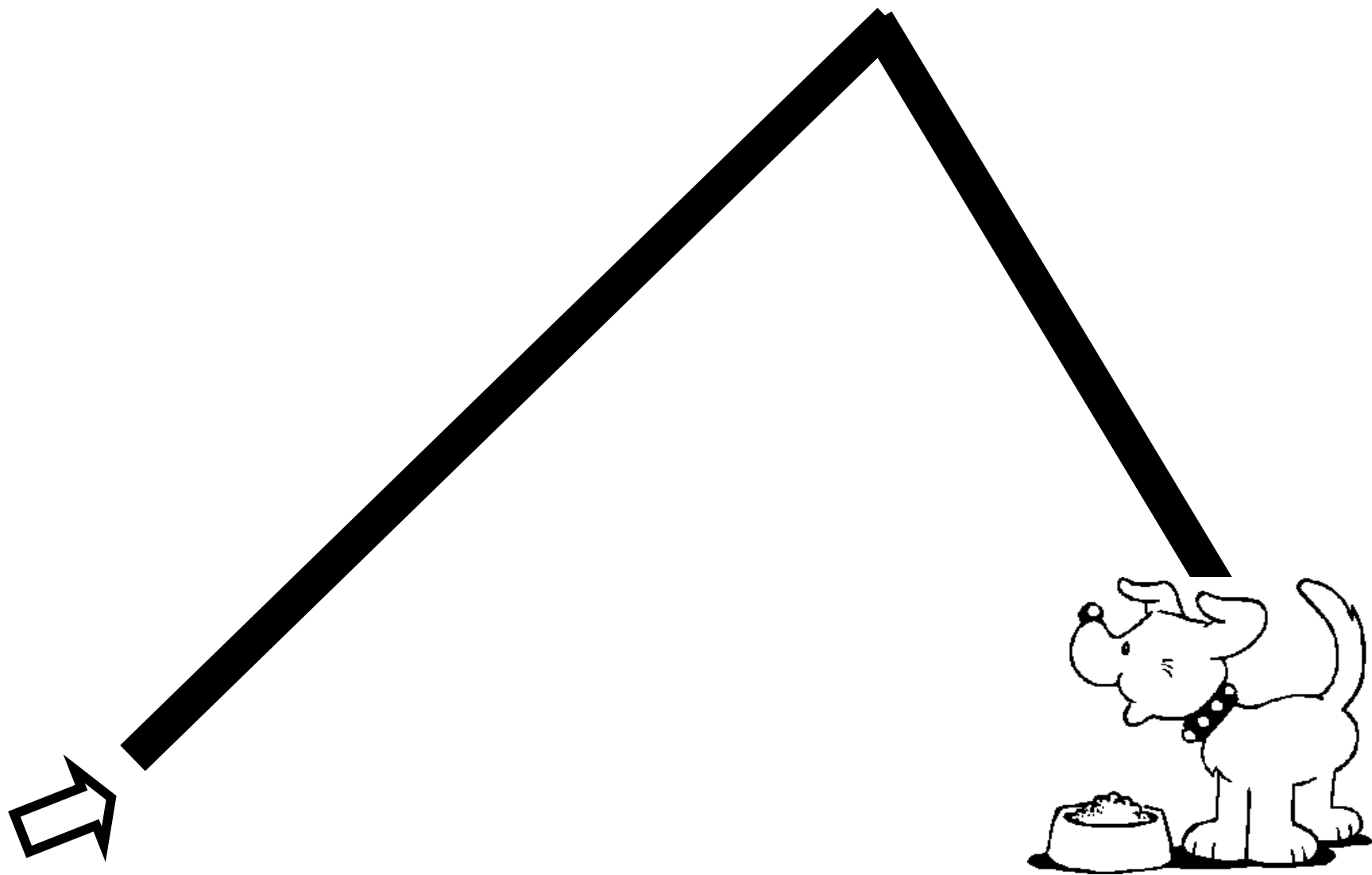

I PERCORSI

Segui con il dito il percorso partendo dalla freccia.

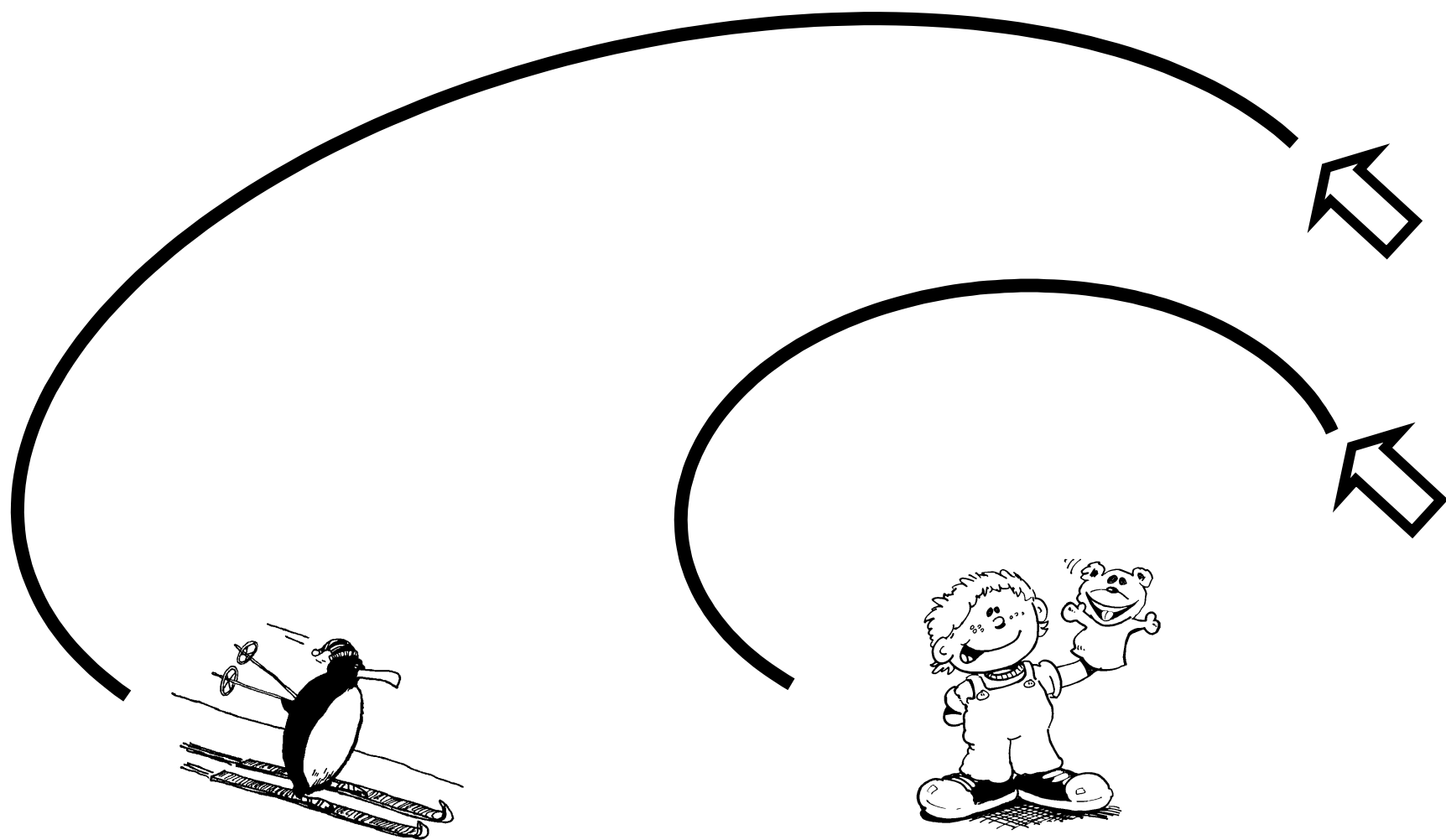

I PERCORSI

Segui con il dito il percorso partendo dalla freccia.

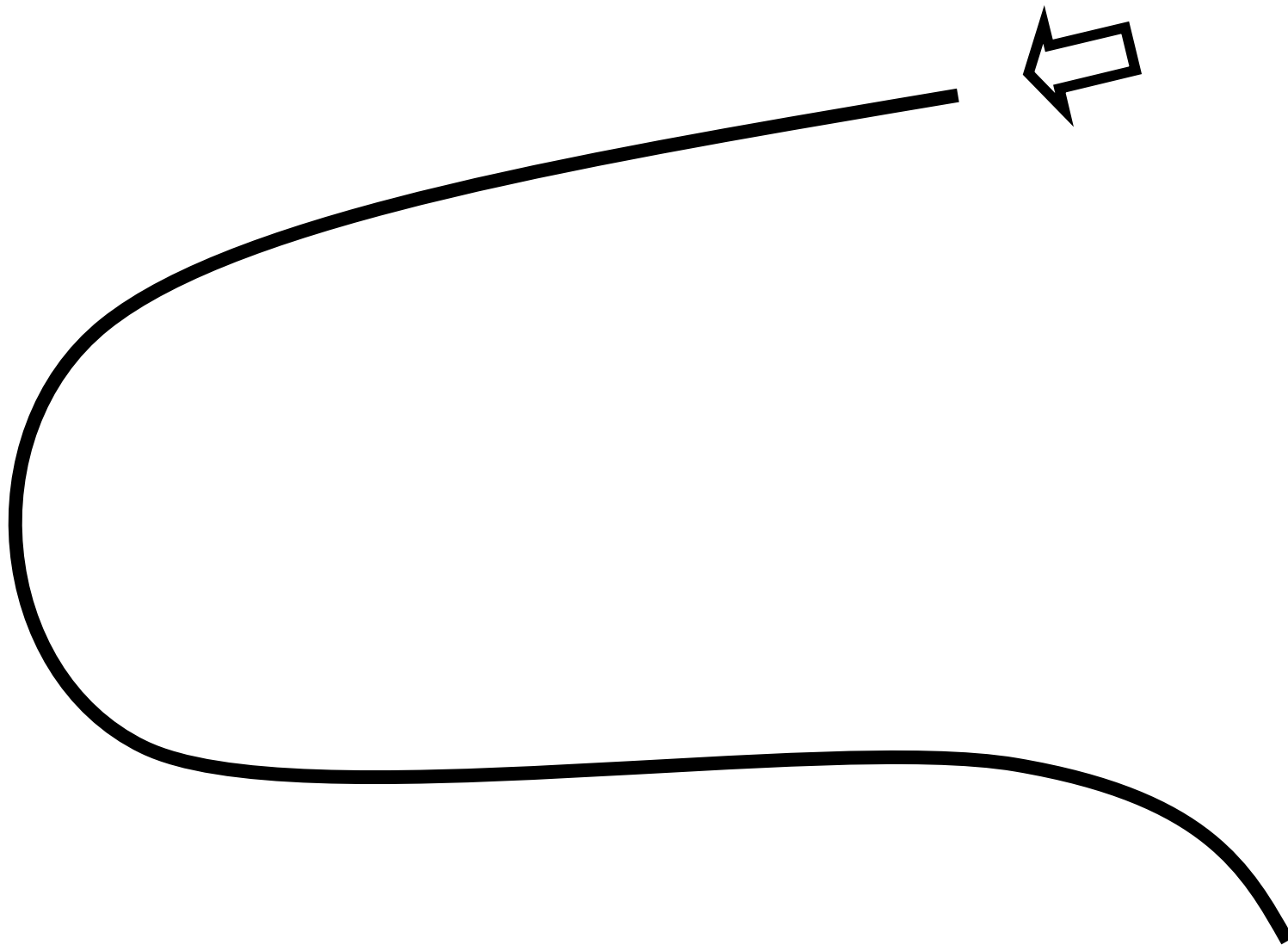

I PERCORSI

Segui con il dito il percorso partendo dalla freccia.

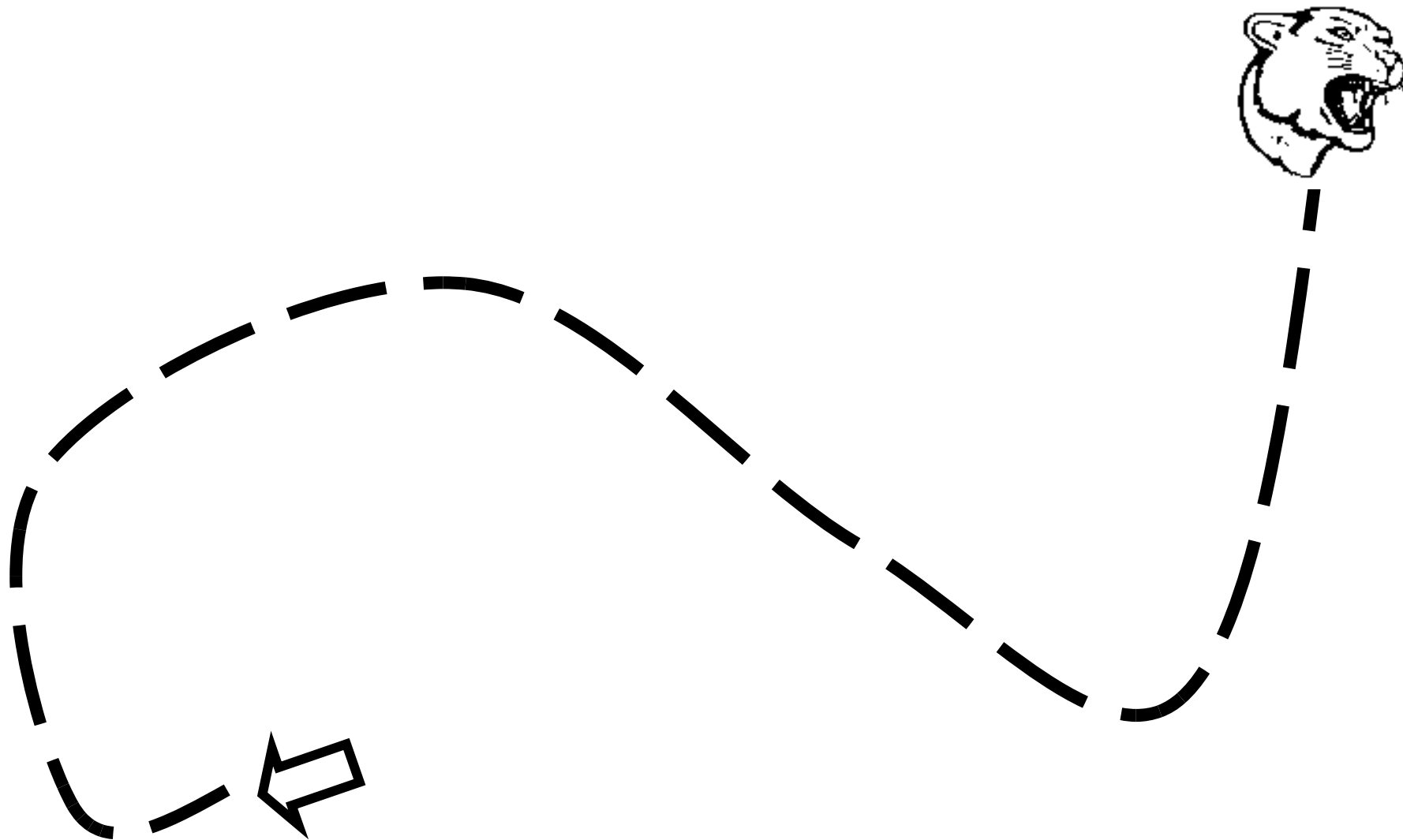

I PERCORSI

Segui con il dito il percorso partendo dalla freccia.

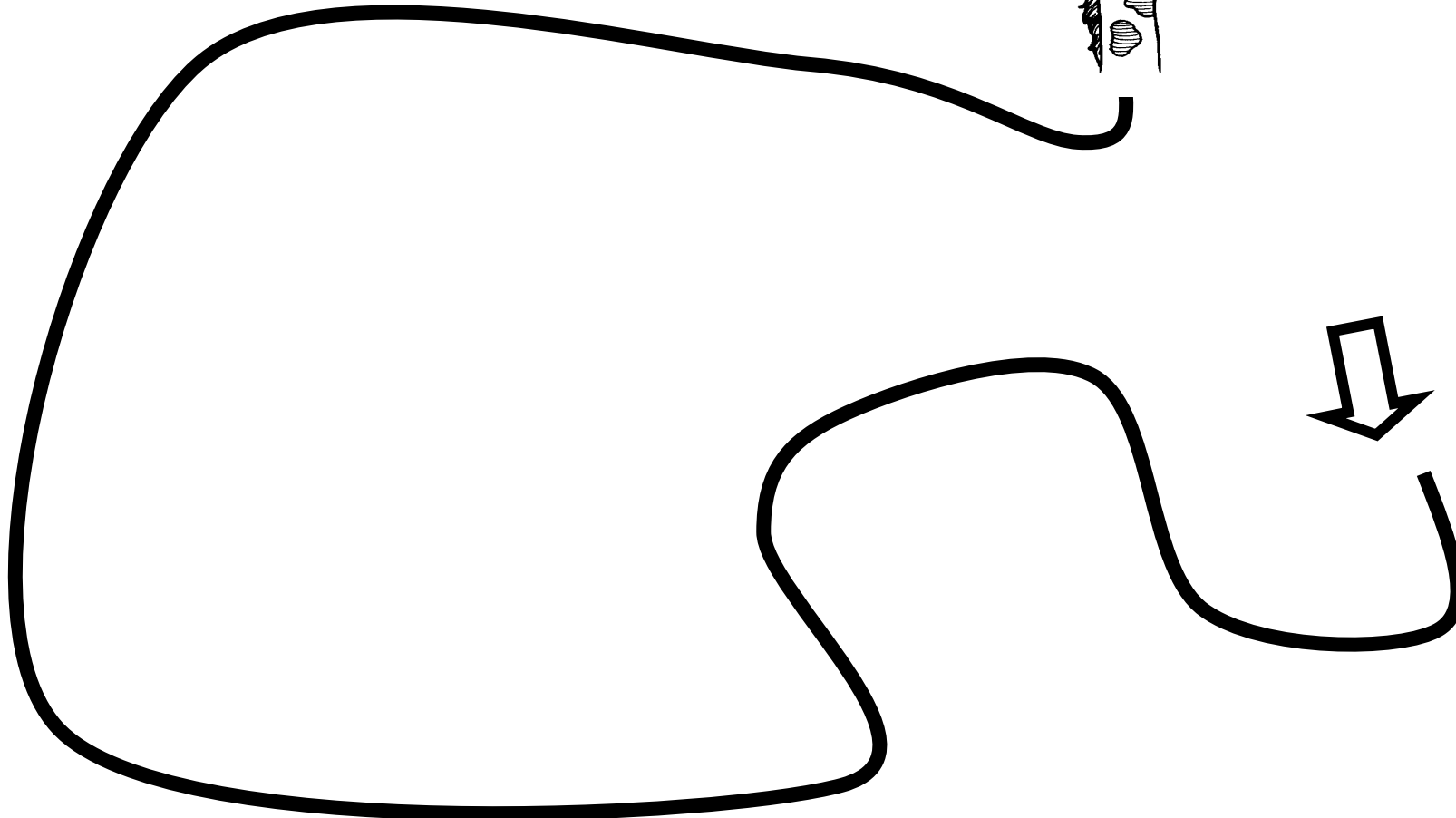

I PERCORSI

Segui con il dito il percorso partendo dalla freccia.

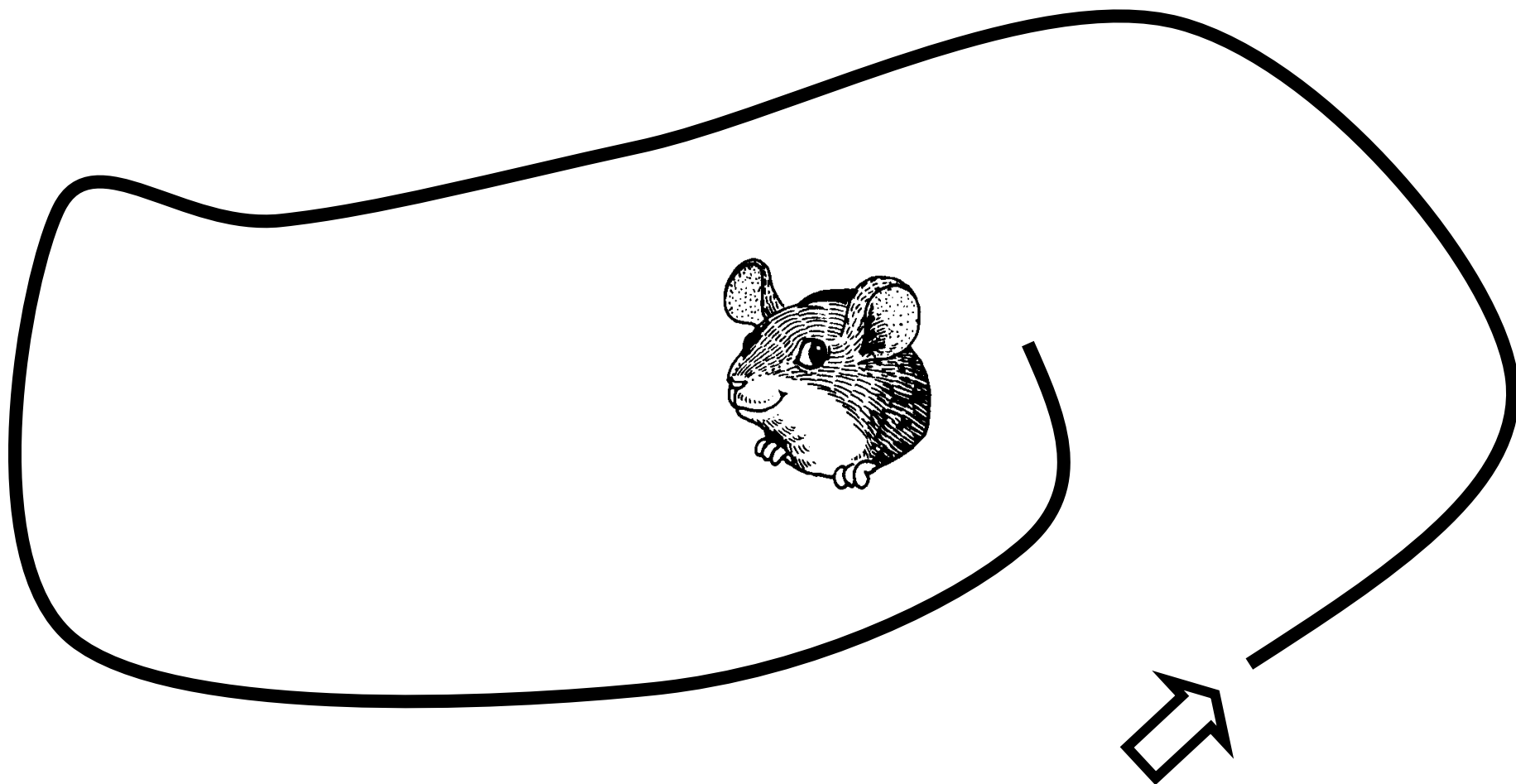

I PERCORSI

Segui con il dito il percorso partendo dalla freccia.

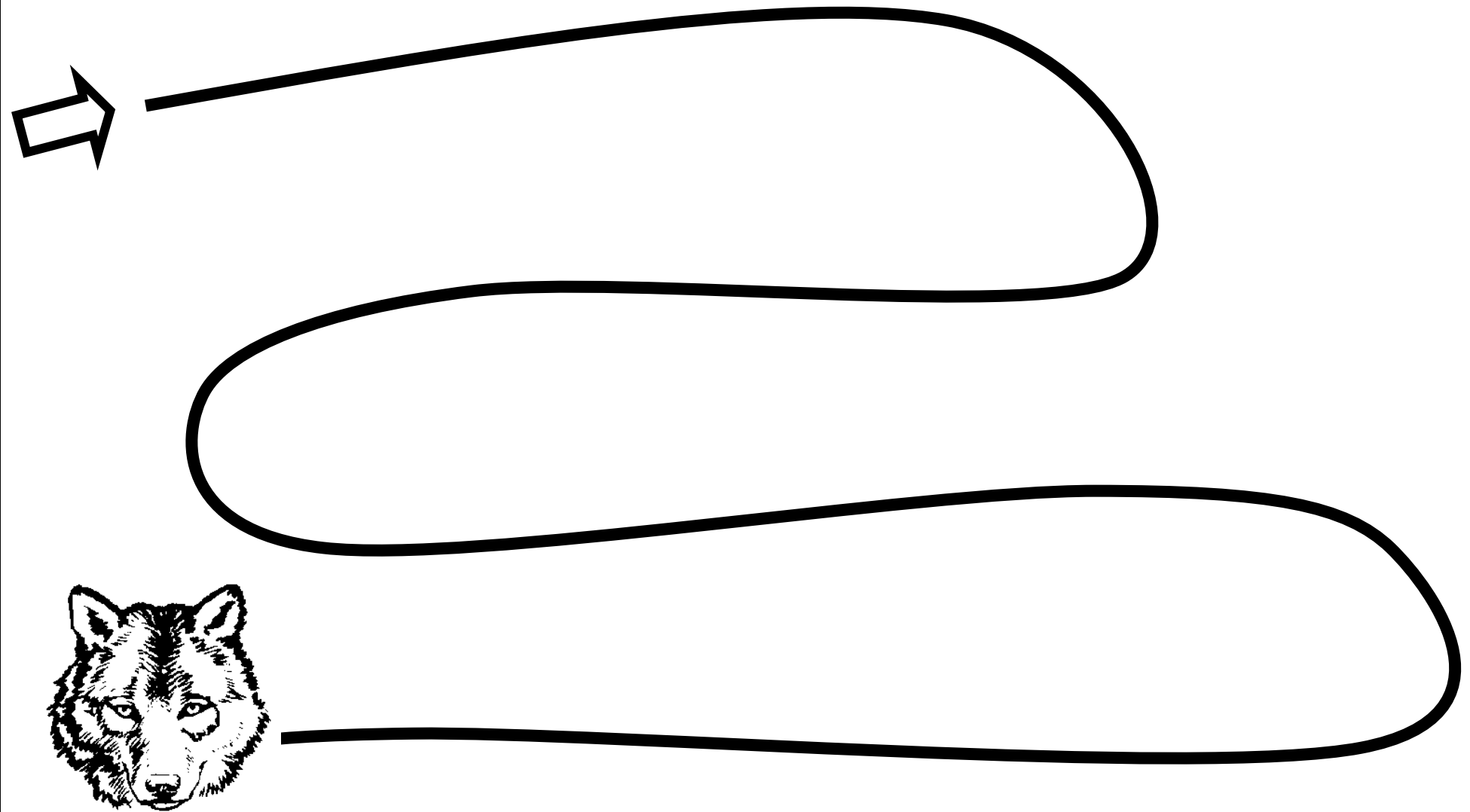

I PERCORSI
Segui con il dito il percorso partendo dalla freccia.

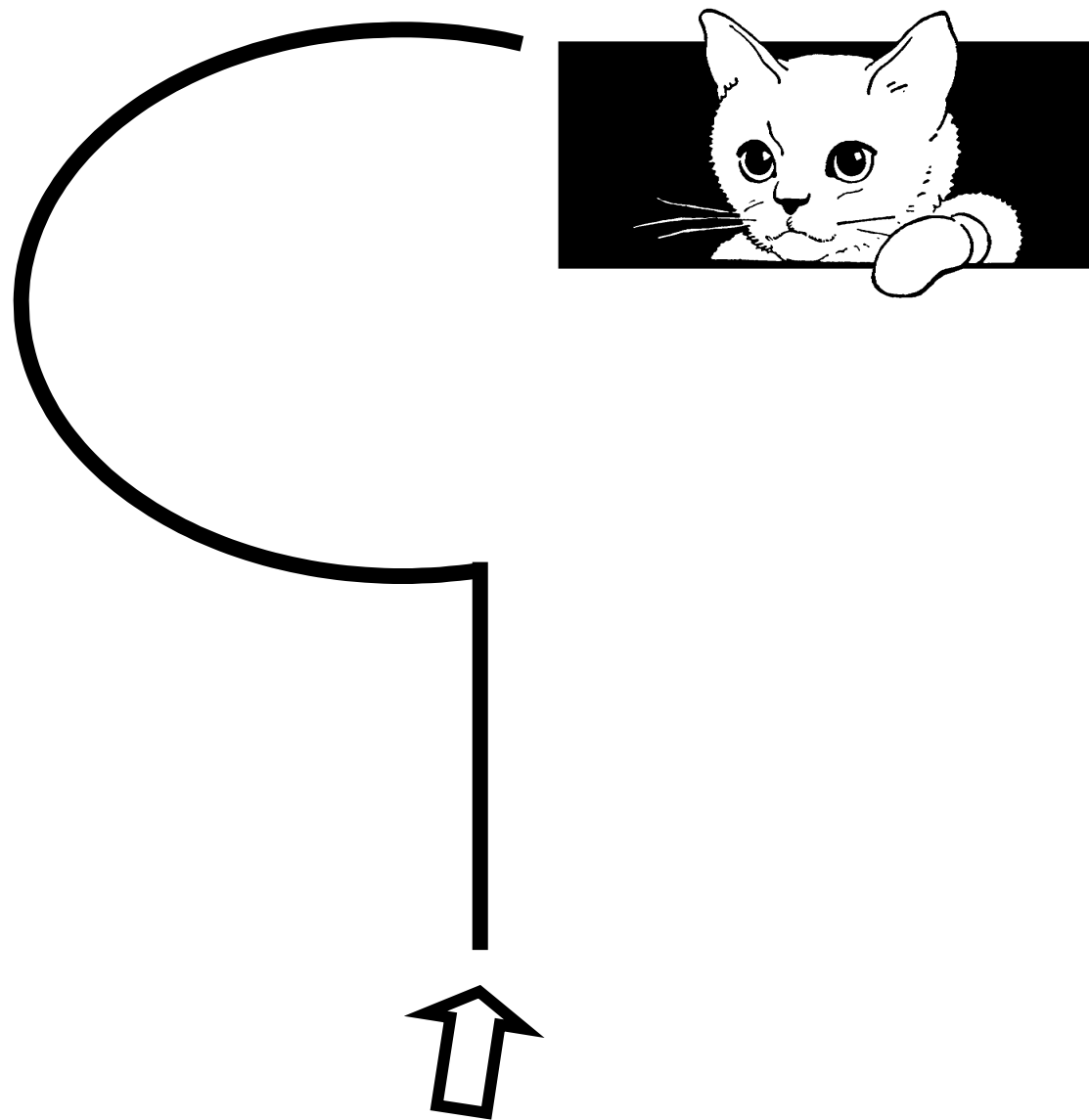

I PERCORSI

Segui con il dito il percorso partendo dalla freccia.

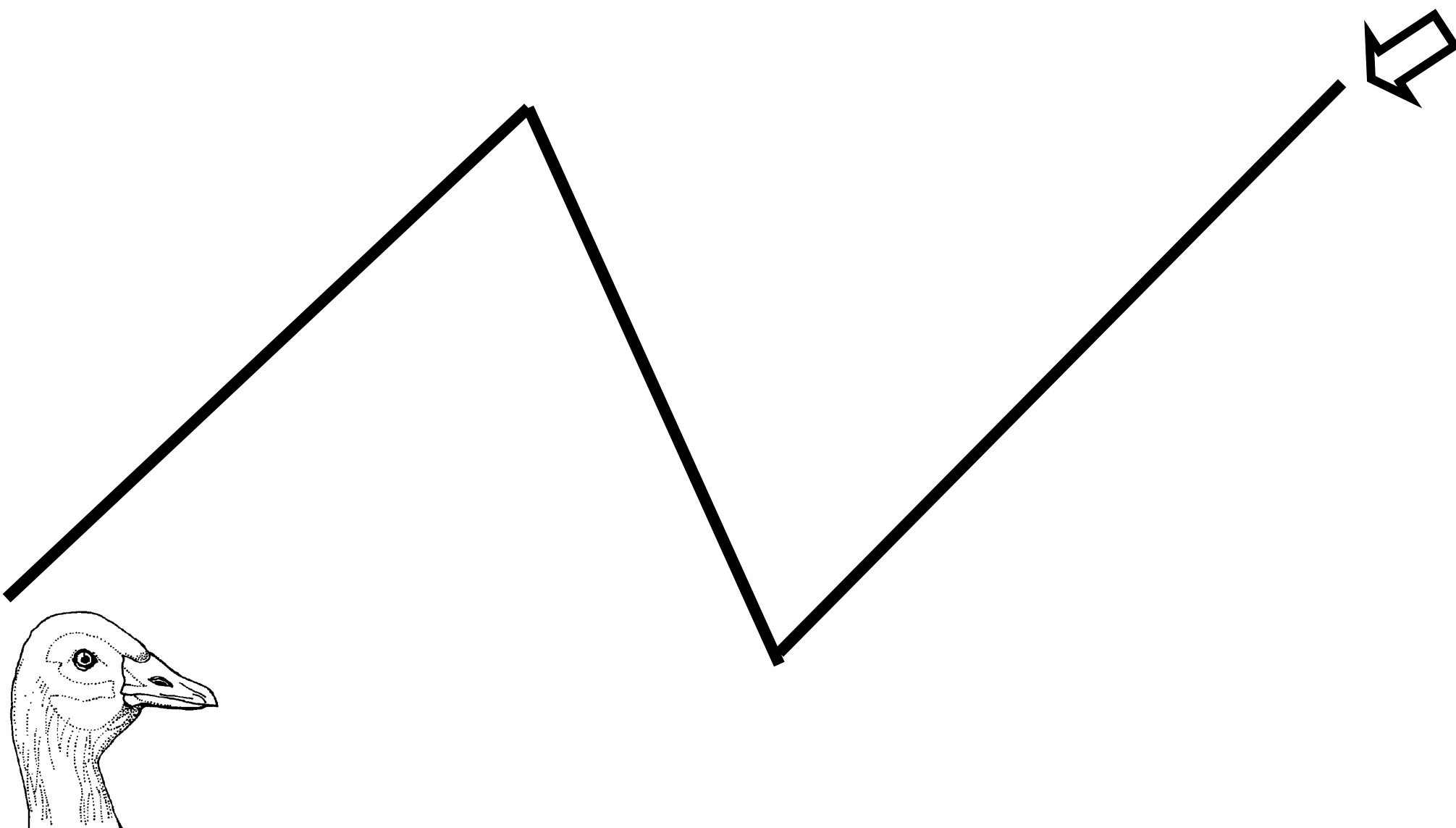

I PERCORSI

Segui con il dito il percorso partendo dalla freccia.

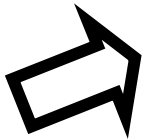
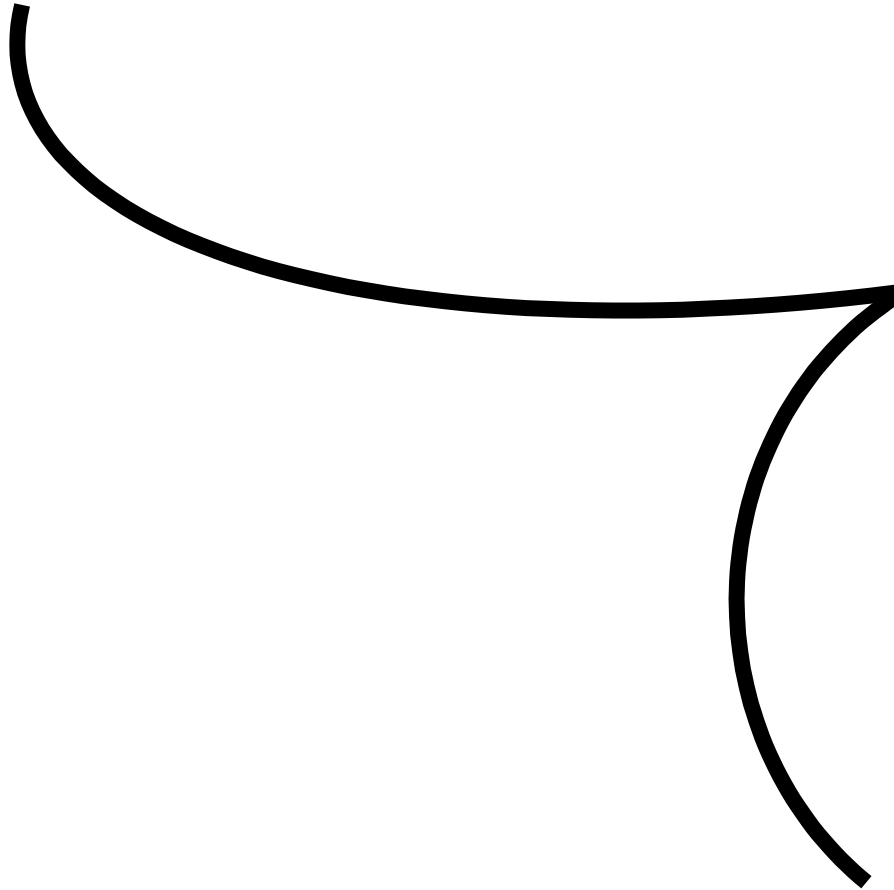
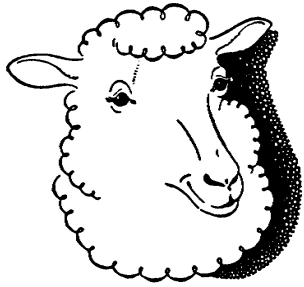

I PERCORSI

Segui con il dito il percorso partendo dalla freccia.

“ VOGLIA DI CRESCERE ”

PROGRAMMA BASE PER LO SVILUPPO LOGICO E COGNITIVO

ASSOCIAZIONI DI FIGURE GEOMETRICHE UGUALI

ASSOCIAZIONI DI FIGURE GEOMETRICHE UGUALI

La possibilità di stimolazione logica in pratica fino ai tre anni, coincide per lo più con lo sviluppo psicomotorio, percettivo e del linguaggio.

Il bambino manifesta infatti le sue capacità intellettive oltre che sul piano motorio, attraverso un'attività rivolta soprattutto all'analisi, confronto e interpretazione della realtà sensoriale.

Nella sua esplorazione del mondo vengono ad essere coinvolti tutti i sensi per cui è importante, una molteplicità di stimolazioni che li coinvolga.

Maggiore attenzione in questo lavoro viene data alla percezione visiva.

Ciò nasce dal fatto che è più facile per gli studiosi e per gli educatori in genere, preparare materiale graduato e vario composto da immagini, piuttosto che da gusti e da odori.

Le schede che presentiamo sono formate da figure geometriche uguali da associare, che hanno lo scopo di sviluppare nel minore non solo la percezione visiva, ma anche il linguaggio, i primi processi di astrazione e i fondamentali rapporti spaziali.

Il bambino viene inoltre arricchito da numerosi elementi culturali.

UTILIZZAZIONE

L'educatore indicando la o le figure geometriche poste in alto le denominerà chiedendo al bambino di indicare le figure uguali rappresentate in basso.

ETA' MENTALE DI RIFERIMENTO

Due anni.

ASSOCIAZIONI DI FIGURE GEOMETRICHE UGUALI

Far associare le figure geometriche uguali.

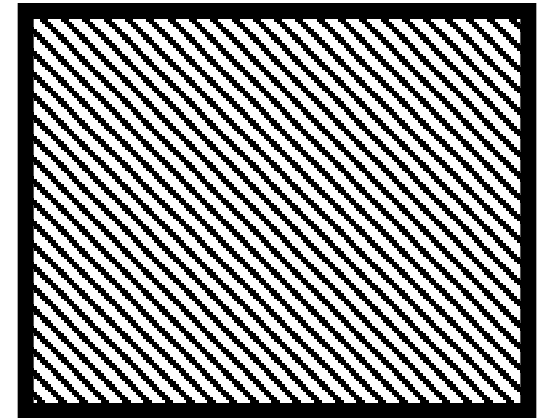
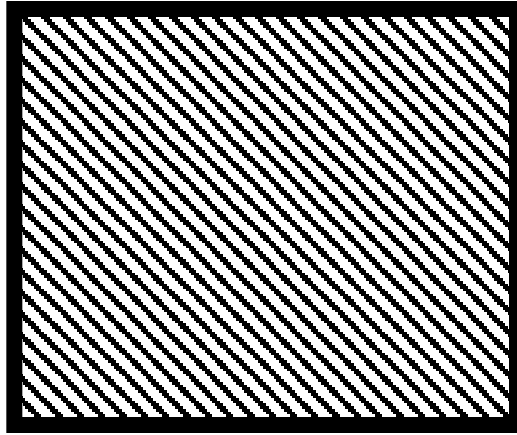

ASSOCIAZIONI DI FIGURE GEOMETRICHE UGUALI

Far associare le figure geometriche uguali.

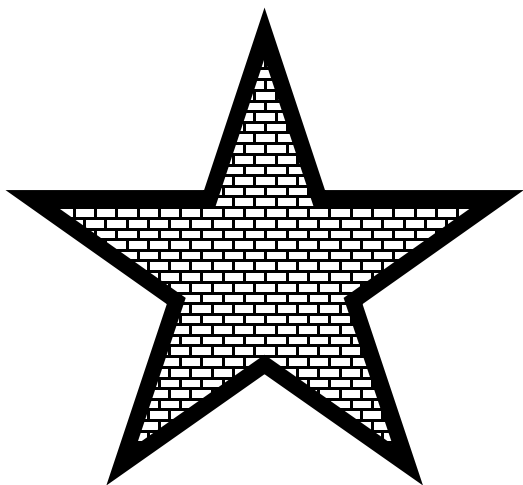
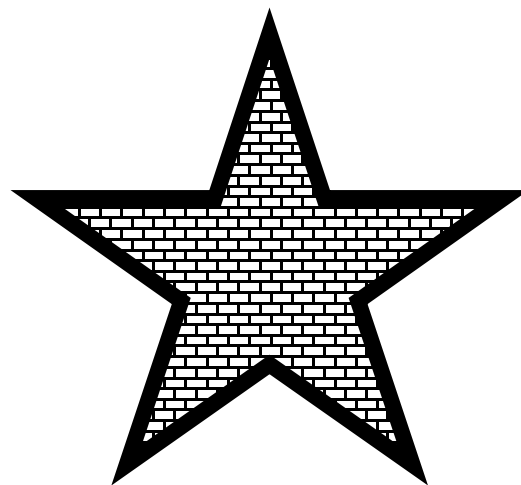

ASSOCIAZIONI DI FIGURE GEOMETRICHE UGUALI

Far associare le figure geometriche uguali.

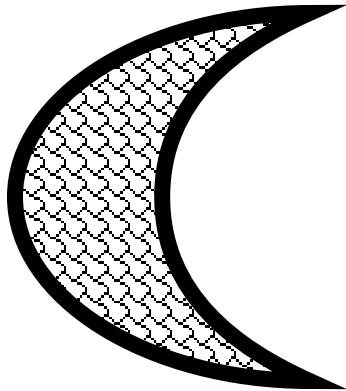
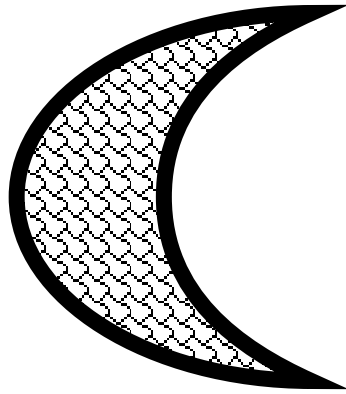

ASSOCIAZIONI DI FIGURE GEOMETRICHE UGUALI

Far associare le figure geometriche uguali.

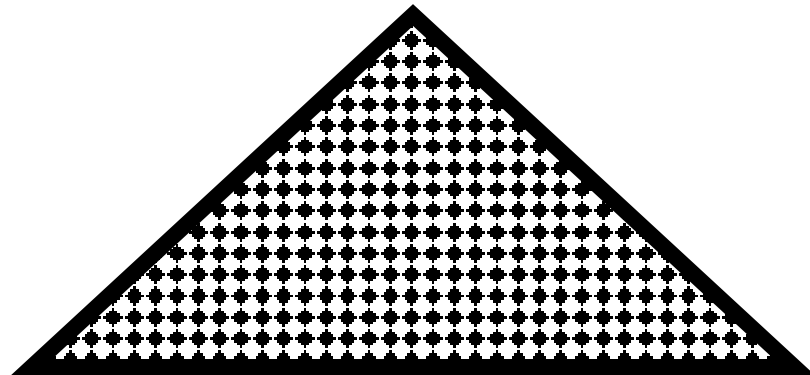
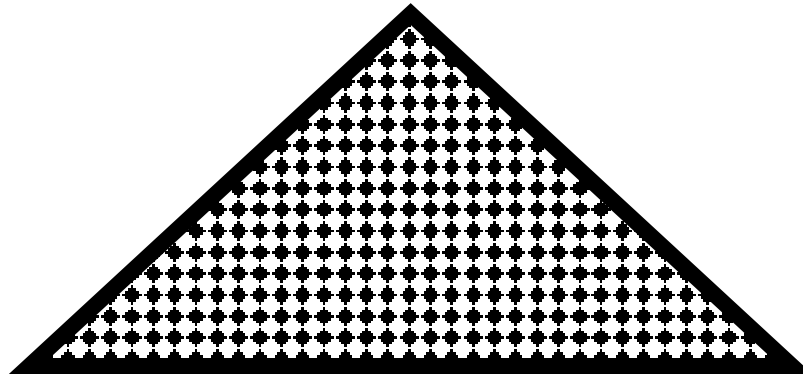

ASSOCIAZIONI DI FIGURE GEOMETRICHE UGUALI

Far associare le figure geometriche uguali.

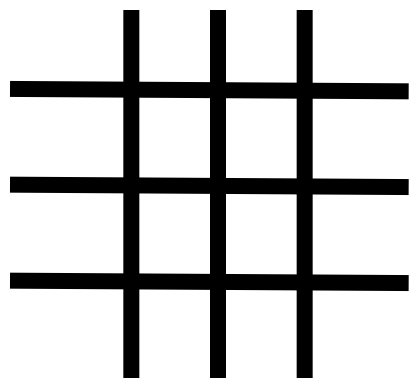
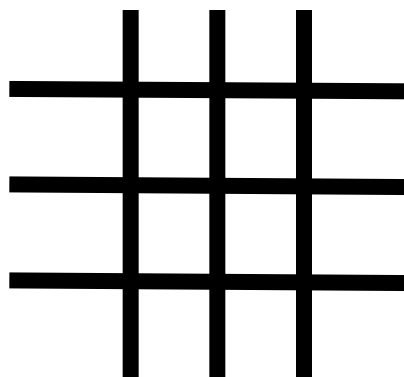

ASSOCIAZIONI DI FIGURE GEOMETRICHE UGUALI

Far associare le figure geometriche uguali.

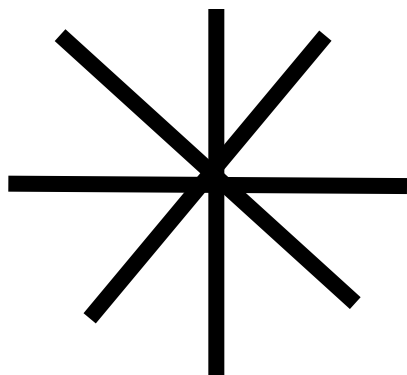
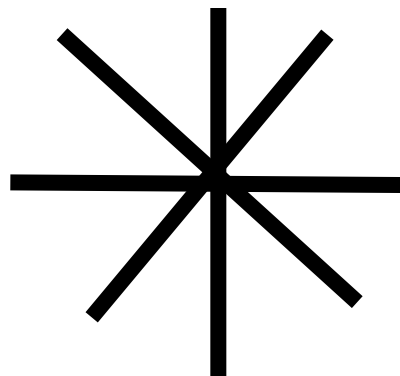

ASSOCIAZIONI DI FIGURE GEOMETRICHE UGUALI

Far associare le figure geometriche uguali.

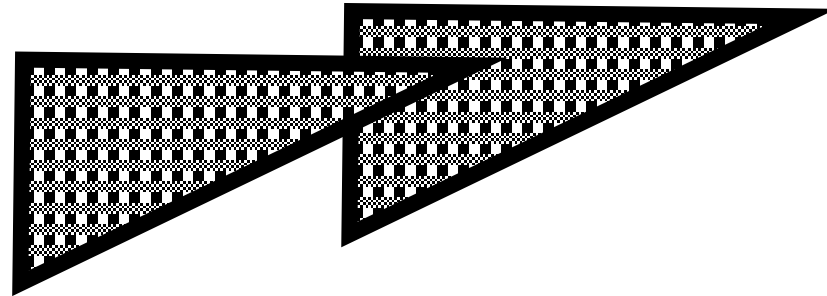
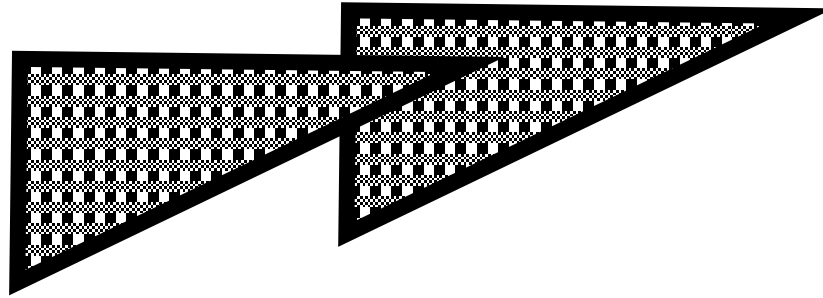

ASSOCIAZIONI DI FIGURE GEOMETRICHE UGUALI

Far associare le figure geometriche uguali.

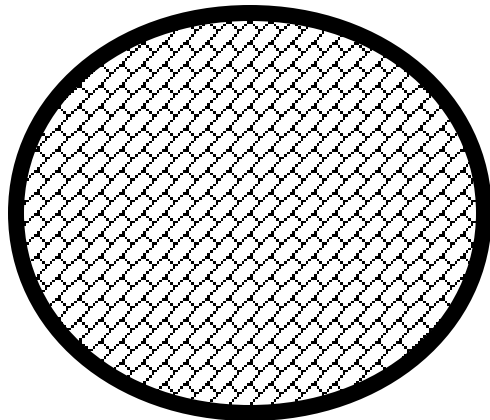
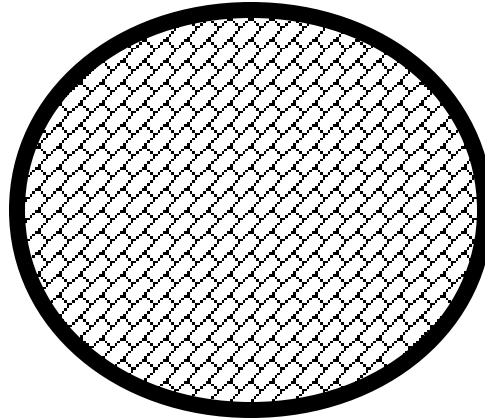

ASSOCIAZIONI DI FIGURE GEOMETRICHE UGUALI

Far associare le figure geometriche uguali.

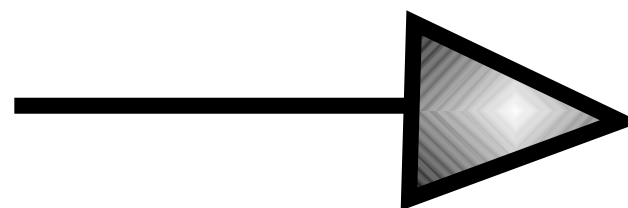
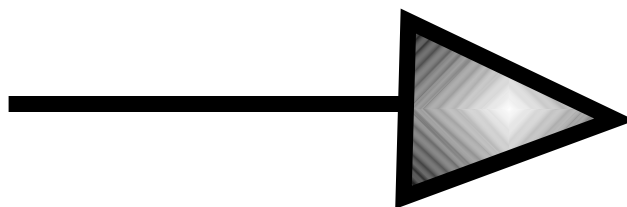

ASSOCIAZIONI DI FIGURE GEOMETRICHE UGUALI

Far associare le figure geometriche uguali.

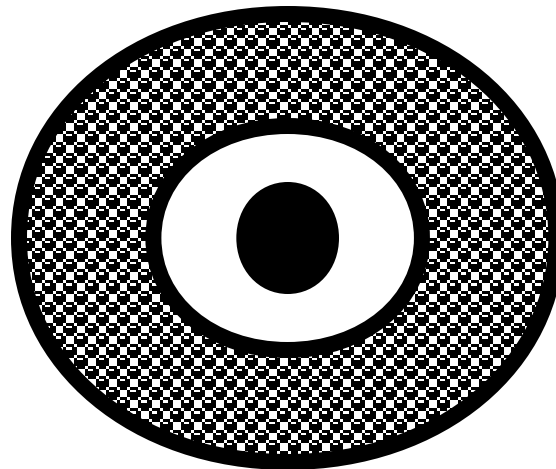
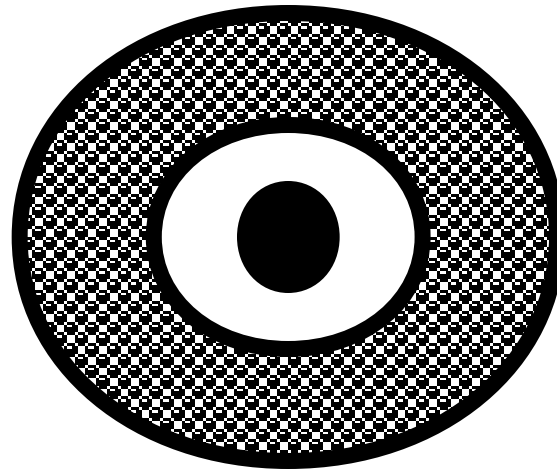

ASSOCIAZIONI DI FIGURE GEOMETRICHE UGUALI

Far associare le figure geometriche uguali.

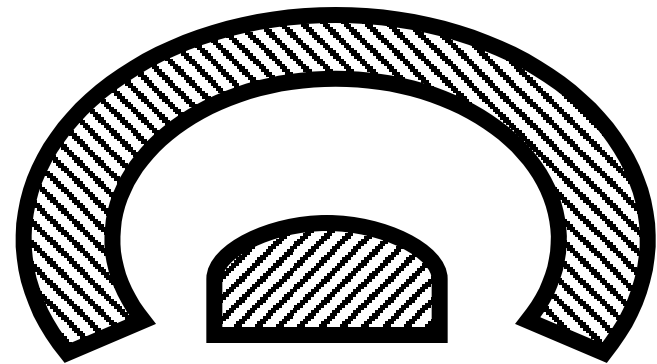
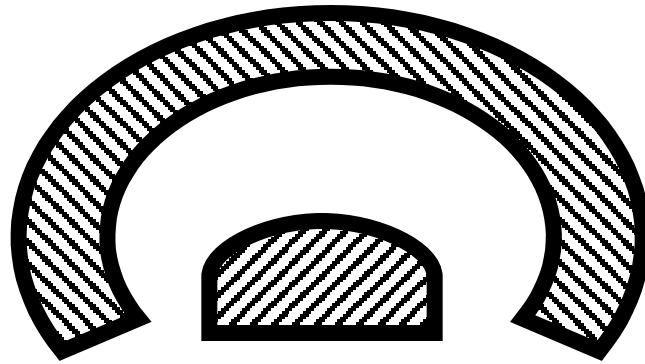

ASSOCIAZIONI DI FIGURE GEOMETRICHE UGUALI

Far associare le figure geometriche uguali.

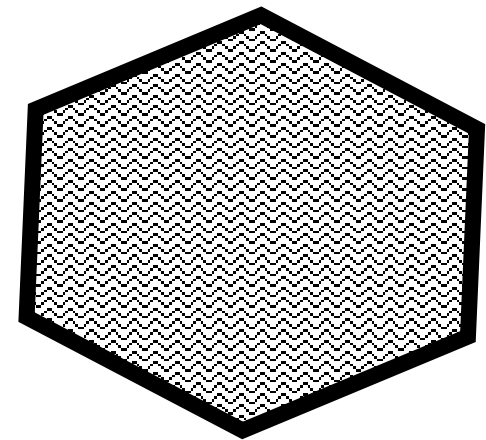
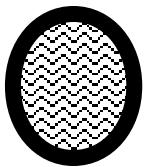
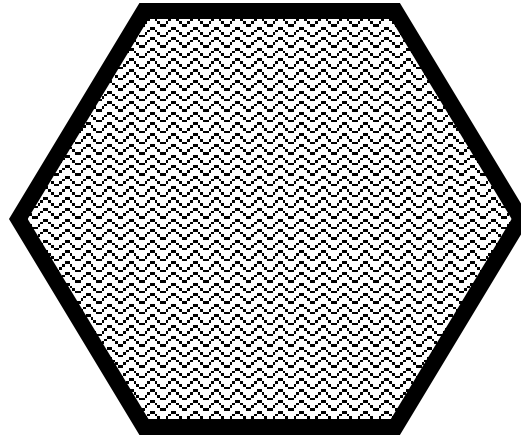

ASSOCIAZIONI DI FIGURE GEOMETRICHE UGUALI

Far associare le figure geometriche uguali.

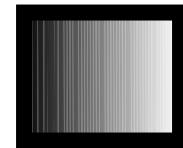
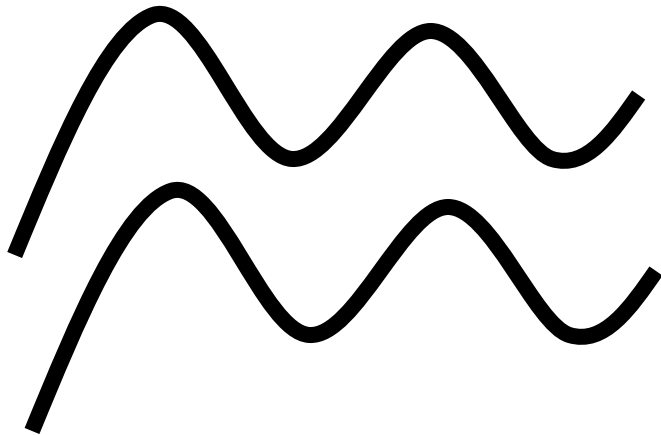
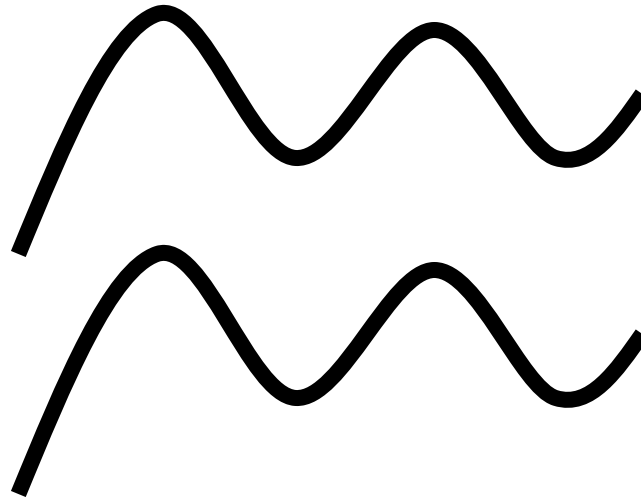

ASSOCIAZIONI DI FIGURE GEOMETRICHE UGUALI

Far associare le figure geometriche uguali.

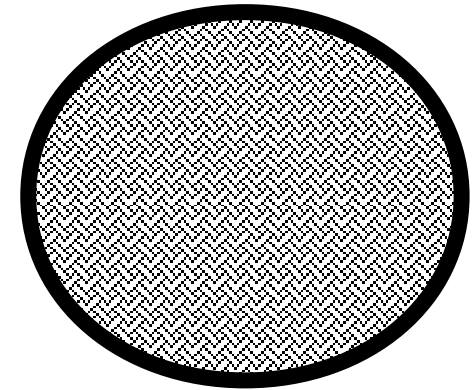
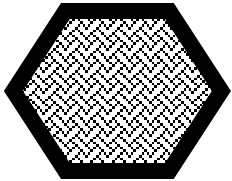
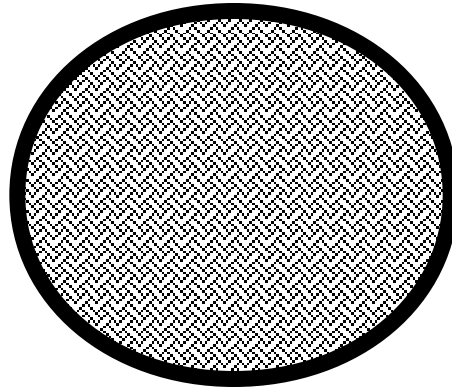

ASSOCIAZIONI DI FIGURE GEOMETRICHE UGUALI

Far associare le figure geometriche uguali.

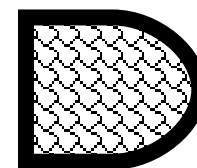
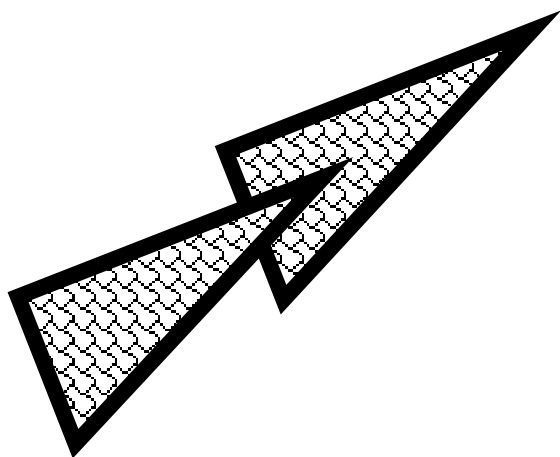
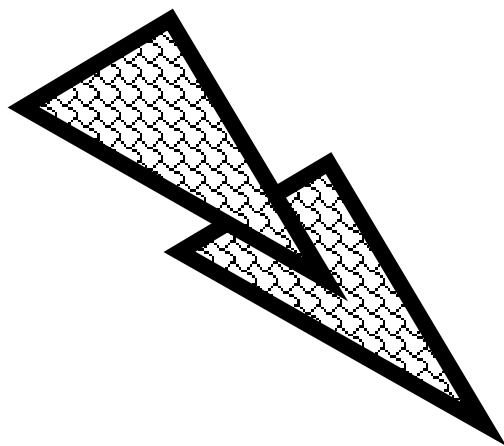

ASSOCIAZIONI DI FIGURE GEOMETRICHE UGUALI

Far associare le figure geometriche uguali.

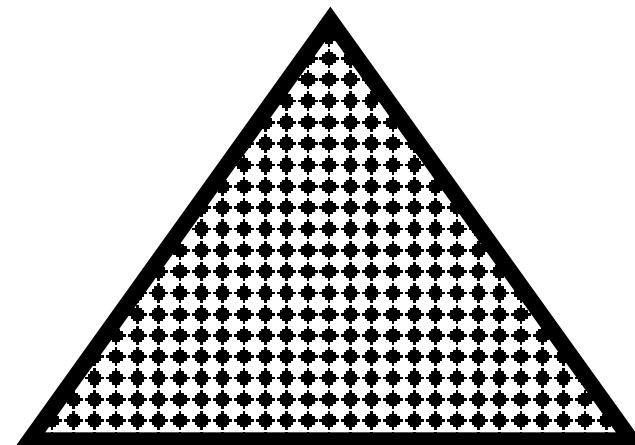
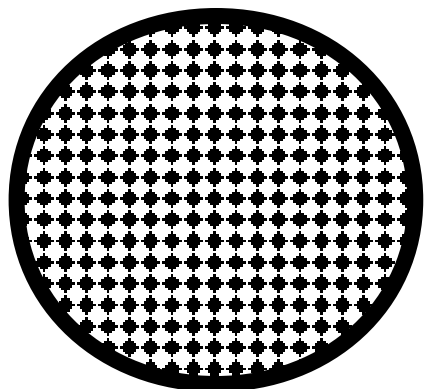
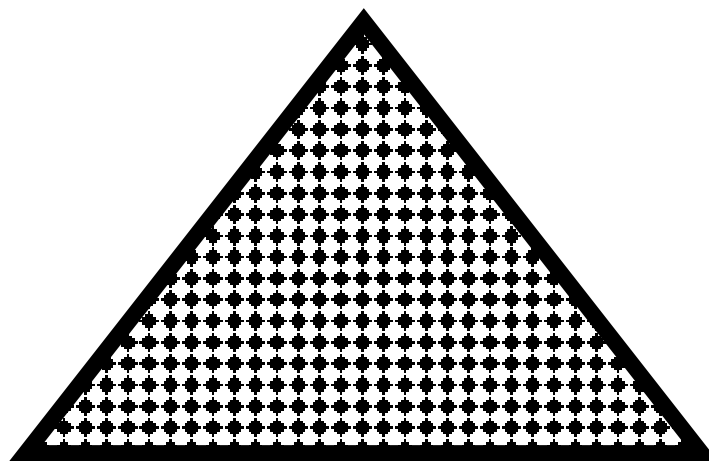

ASSOCIAZIONI DI FIGURE GEOMETRICHE UGUALI

Far associare le figure geometriche uguali.

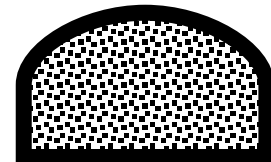
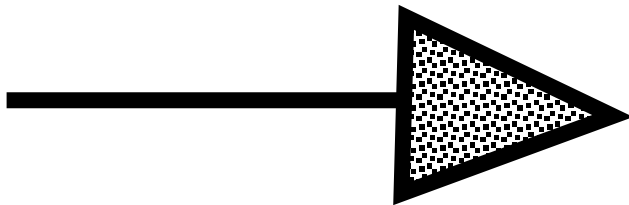
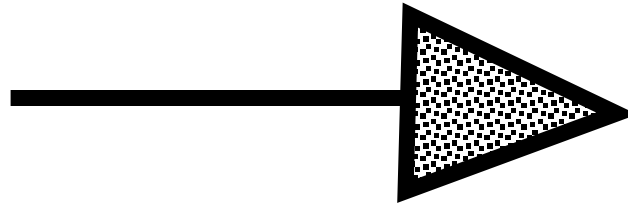

ASSOCIAZIONI DI FIGURE GEOMETRICHE UGUALI

Far associare le figure geometriche uguali.

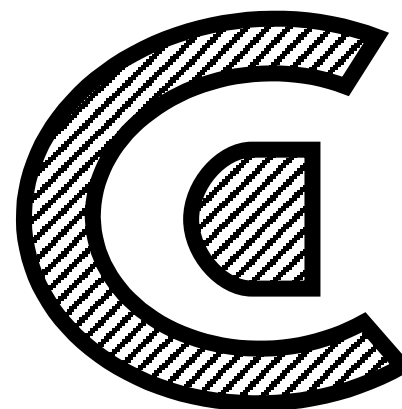
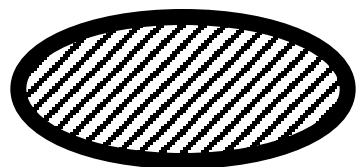
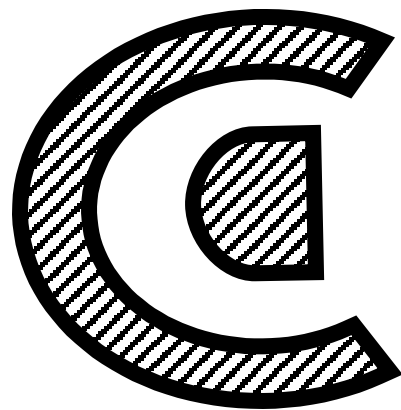

ASSOCIAZIONI DI FIGURE GEOMETRICHE UGUALI

Far associare le figure geometriche uguali.

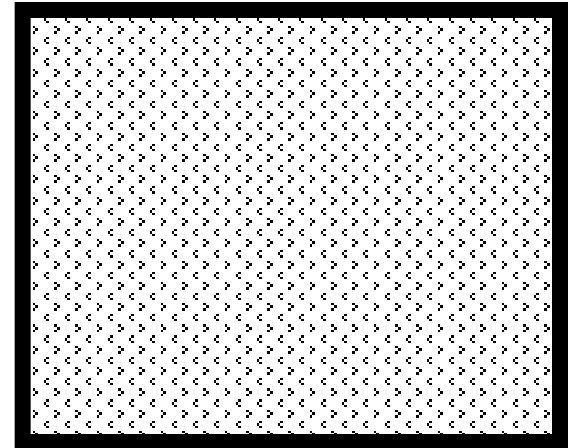
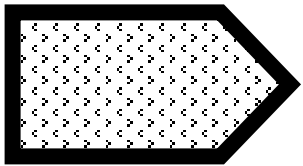
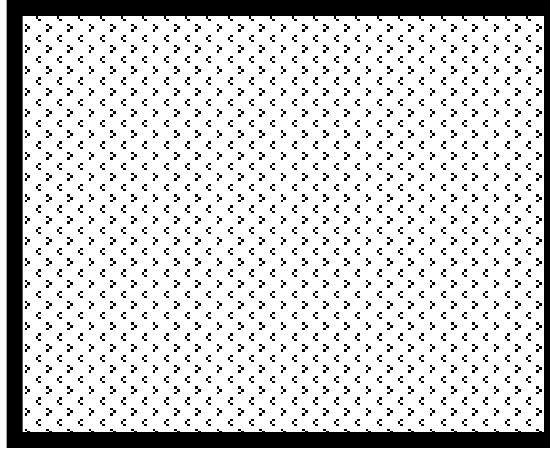

ASSOCIAZIONI DI FIGURE GEOMETRICHE UGUALI

Far associare le figure geometriche uguali.

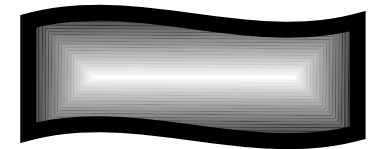
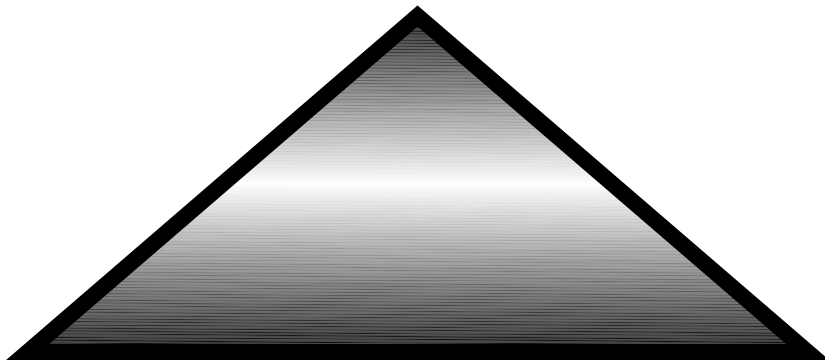
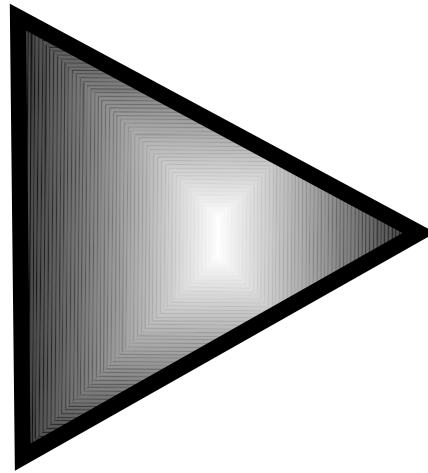

ASSOCIAZIONI DI FIGURE GEOMETRICHE UGUALI

Far associare le figure geometriche uguali.

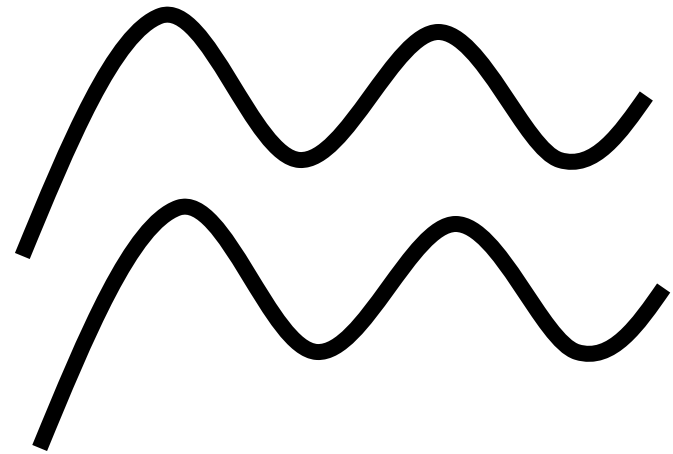
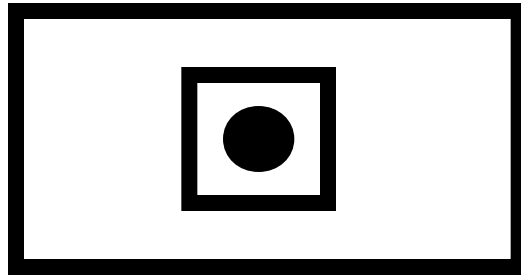
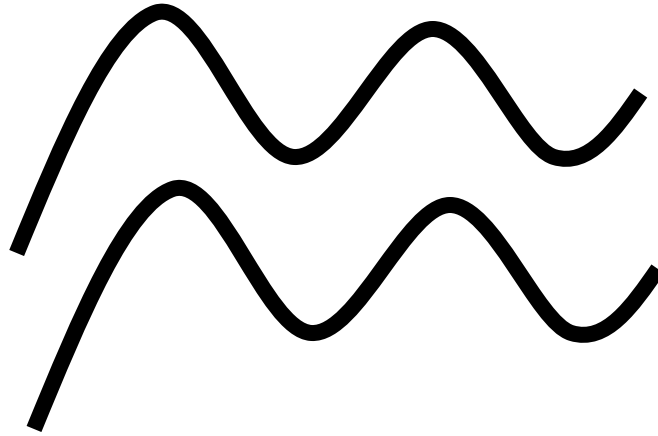

ASSOCIAZIONI DI FIGURE GEOMETRICHE UGUALI

Far associare le figure geometriche uguali.

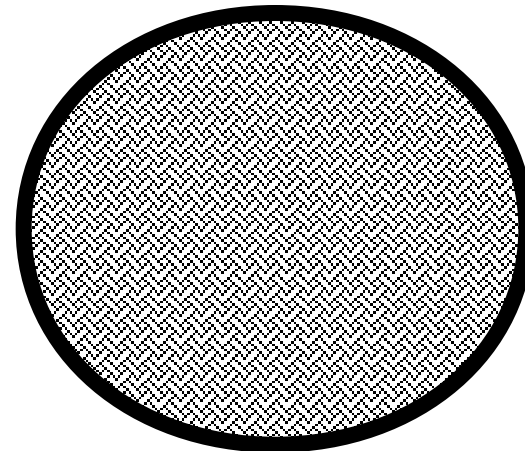
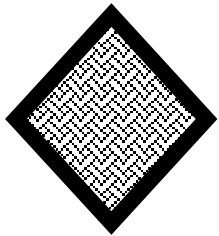
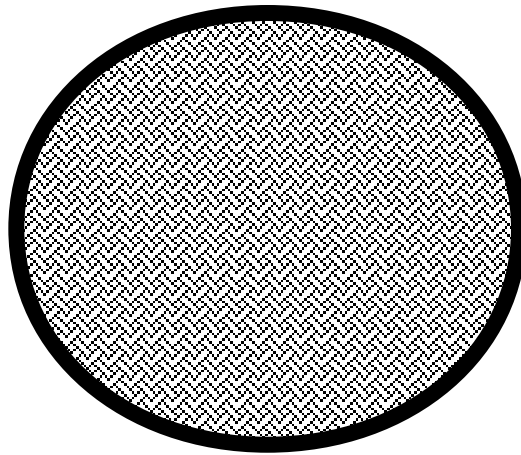

ASSOCIAZIONI DI FIGURE GEOMETRICHE UGUALI

Far associare le figure geometriche uguali.

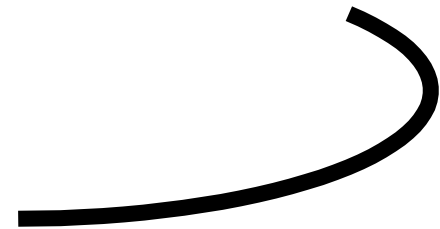
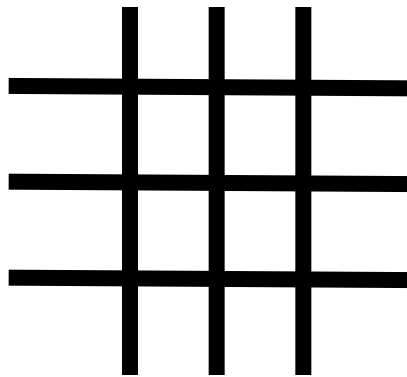
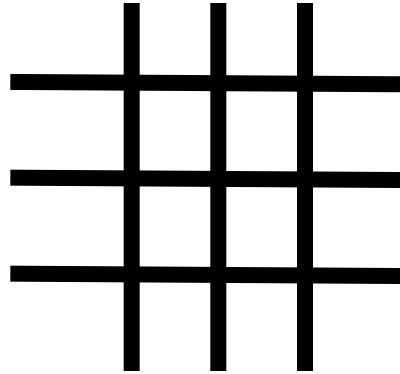

ASSOCIAZIONI DI FIGURE GEOMETRICHE UGUALI

Far associare le figure geometriche uguali.

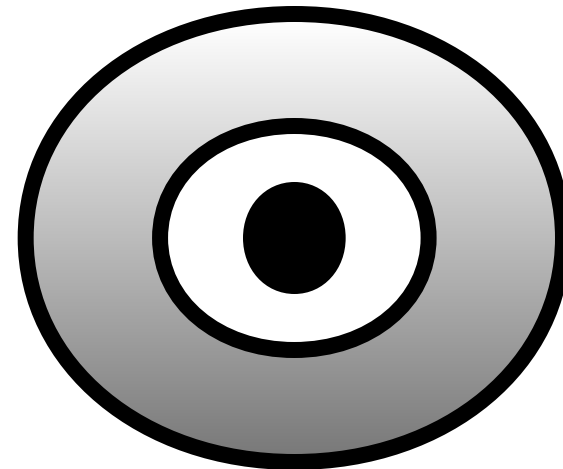
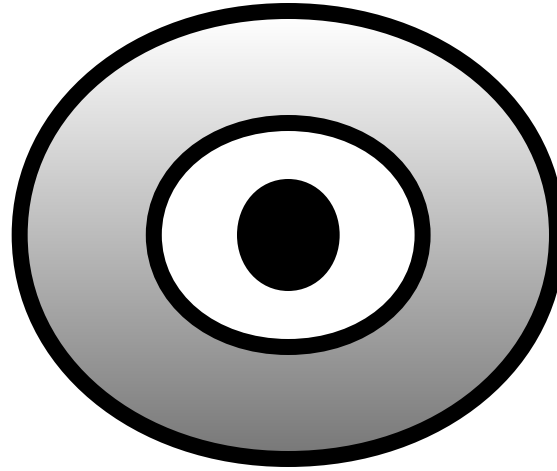

ASSOCIAZIONI DI FIGURE GEOMETRICHE UGUALI

Far associare le figure geometriche uguali.

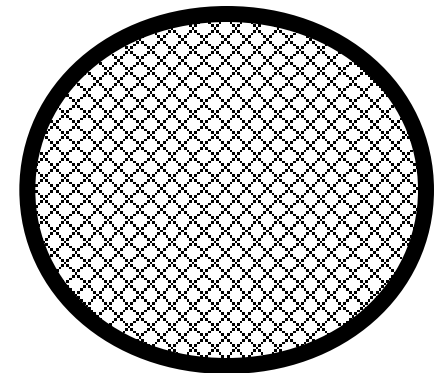
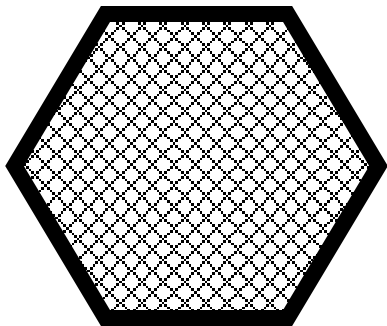
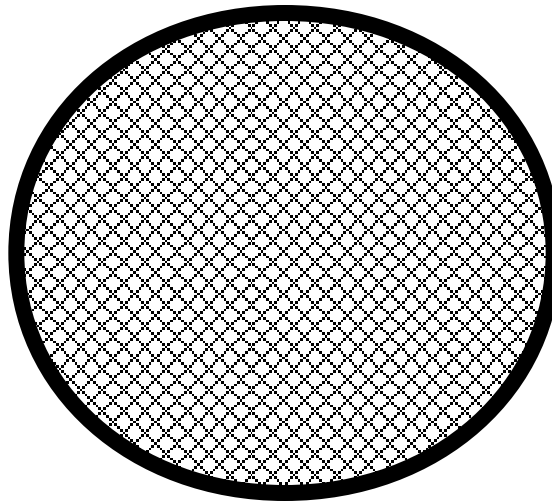

ASSOCIAZIONI DI FIGURE GEOMETRICHE UGUALI

Far associare le figure geometriche uguali.

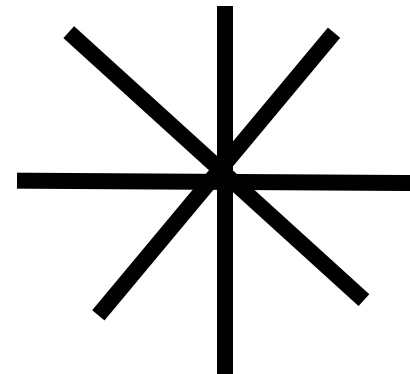
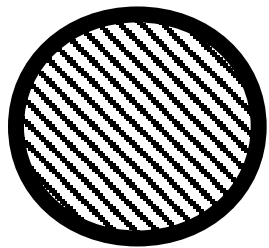
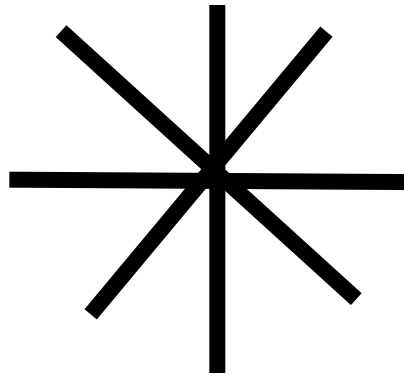

ASSOCIAZIONI DI FIGURE GEOMETRICHE UGUALI

Far associare le figure geometriche uguali.

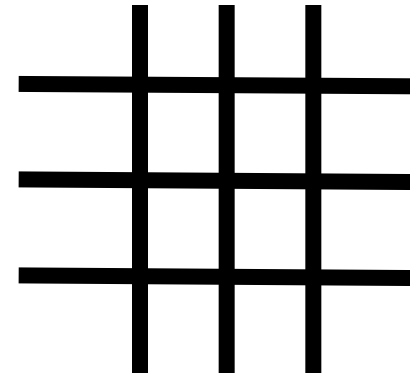
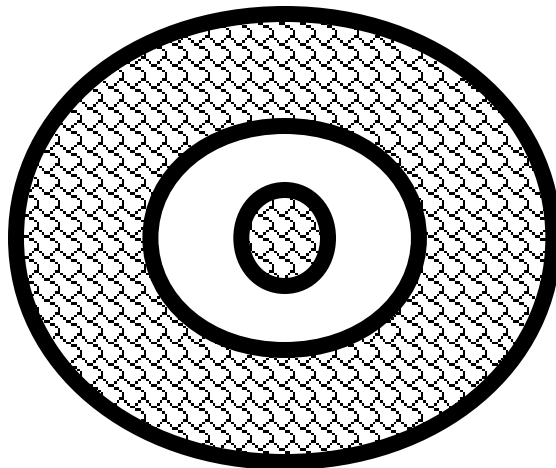
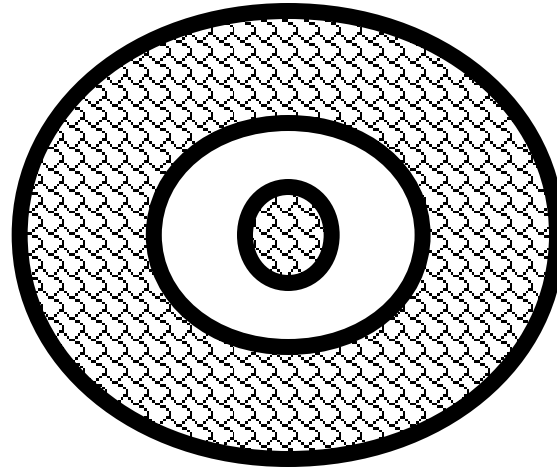

ASSOCIAZIONI DI FIGURE GEOMETRICHE UGUALI

Far associare le figure geometriche uguali.

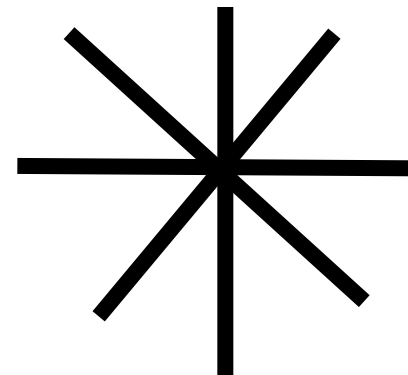
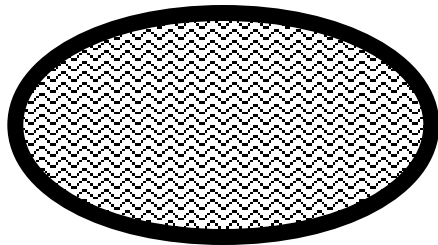
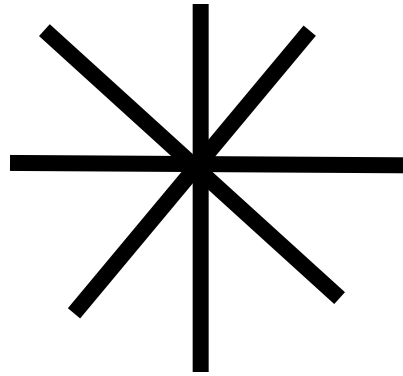

ASSOCIAZIONI DI FIGURE GEOMETRICHE UGUALI

Far associare le figure geometriche uguali.

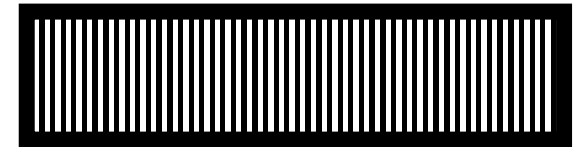
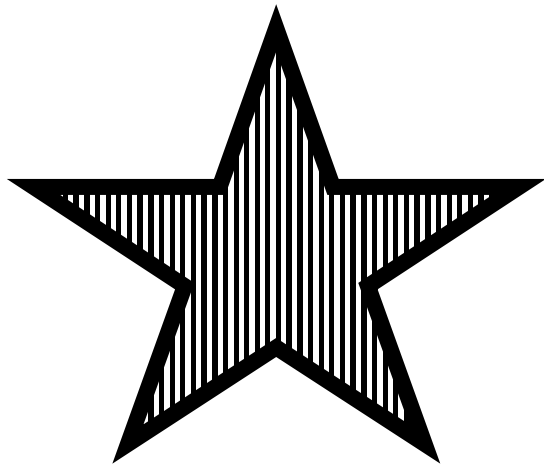
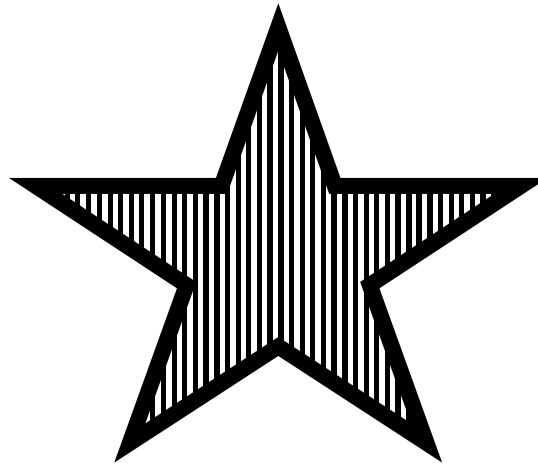

ASSOCIAZIONI DI FIGURE GEOMETRICHE UGUALI

Far associare le figure geometriche uguali.

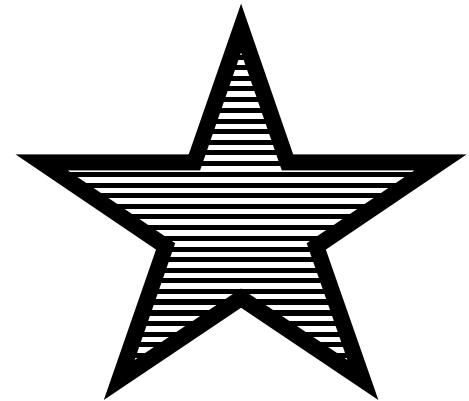
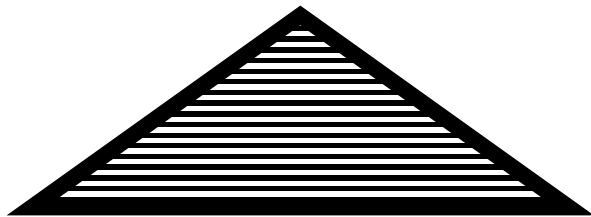
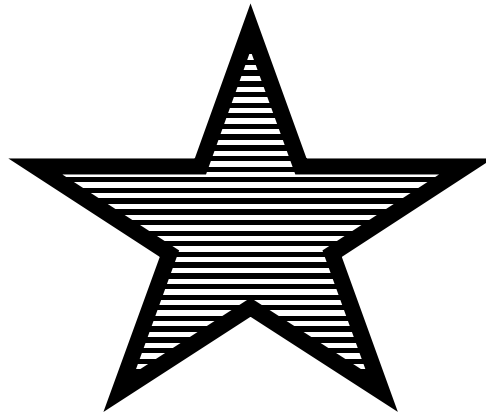

ASSOCIAZIONI DI FIGURE GEOMETRICHE UGUALI

Far associare le figure geometriche uguali.

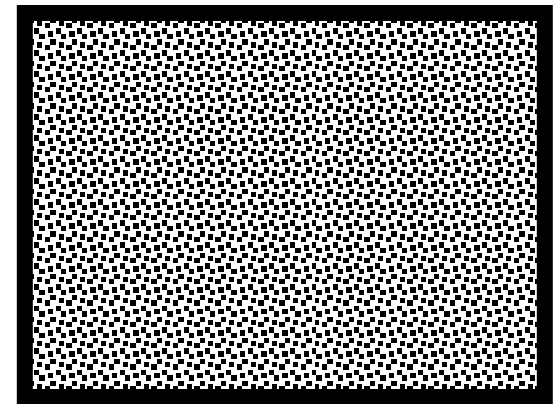
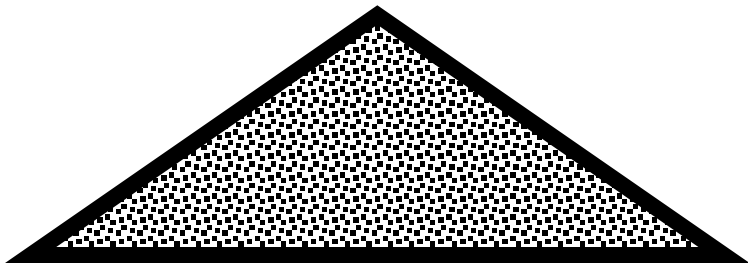
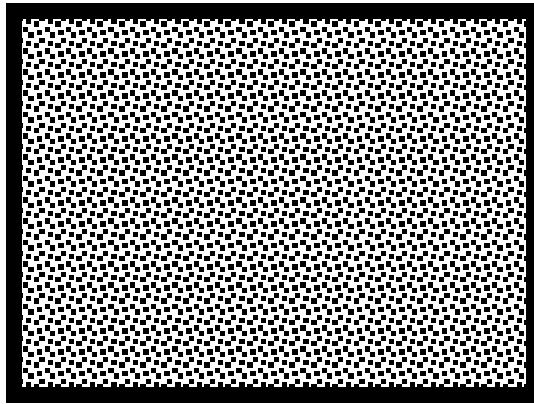

ASSOCIAZIONI DI FIGURE GEOMETRICHE UGUALI

Far associare le figure geometriche uguali.

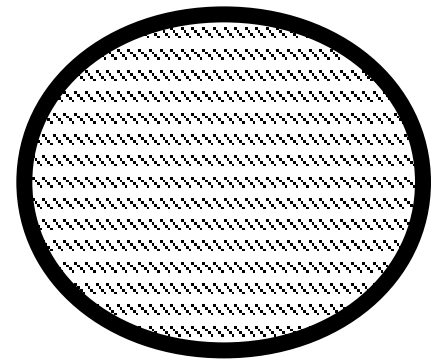
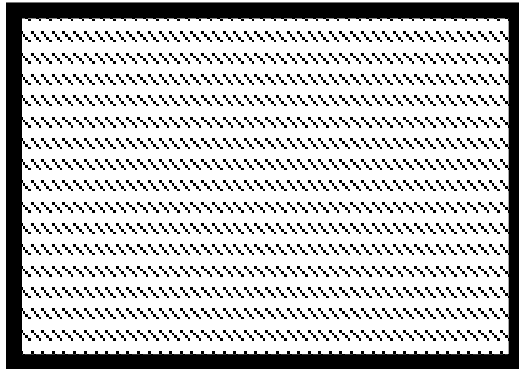
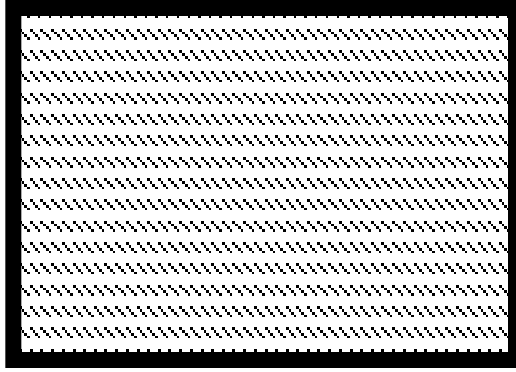

ASSOCIAZIONI DI FIGURE GEOMETRICHE UGUALI

Far associare le figure geometriche uguali.

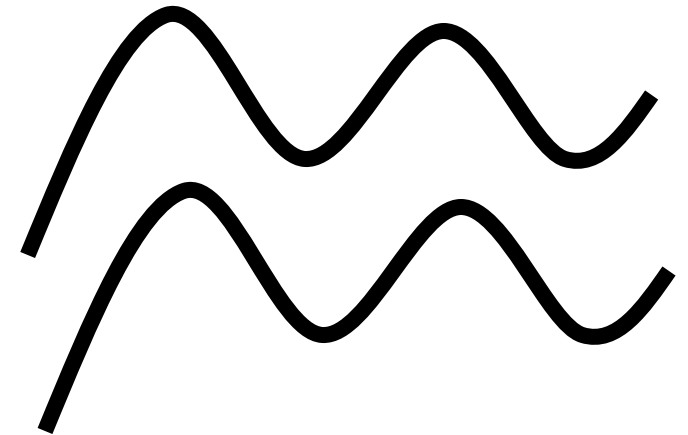
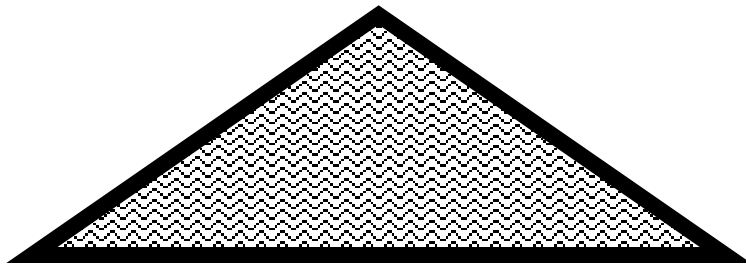
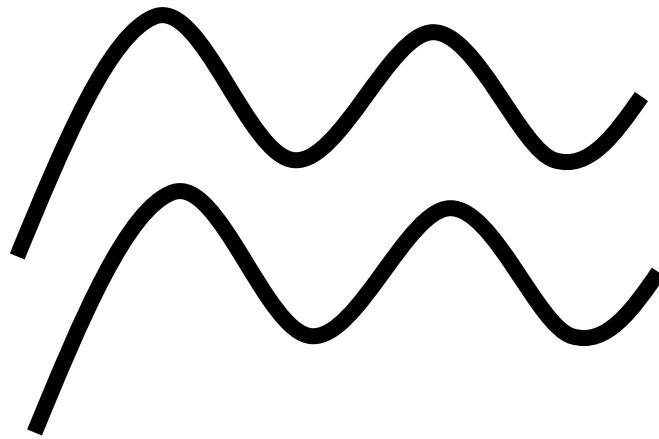

ASSOCIAZIONI DI FIGURE GEOMETRICHE UGUALI

Far associare le figure geometriche uguali.

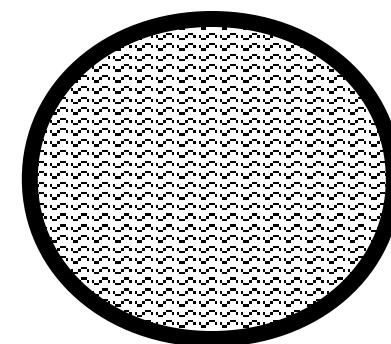
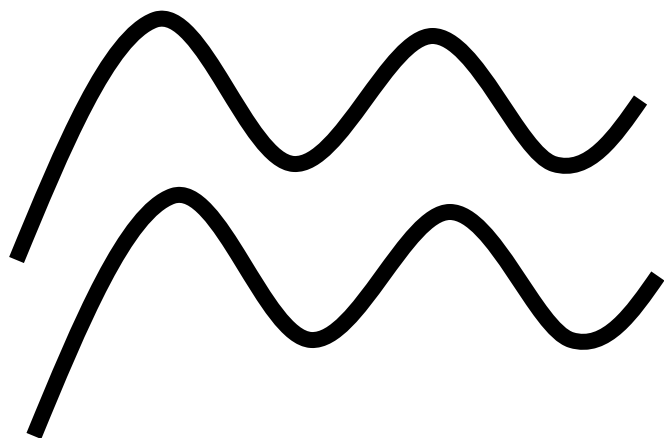
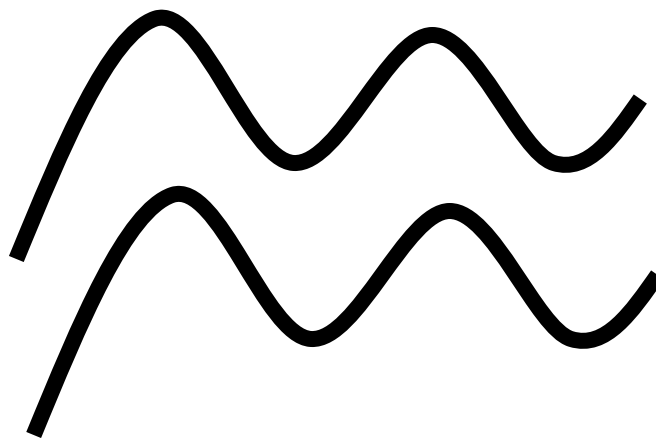

ASSOCIAZIONI DI FIGURE GEOMETRICHE UGUALI

Far associare le figure geometriche uguali.

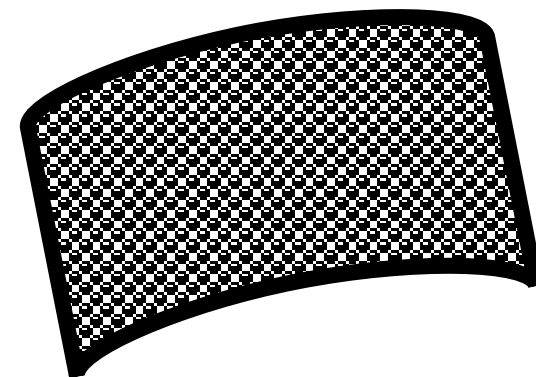
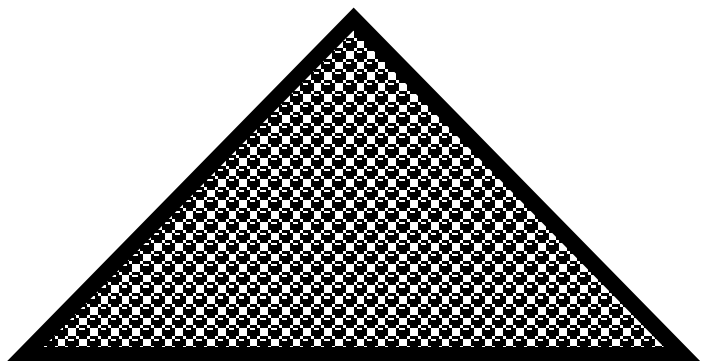
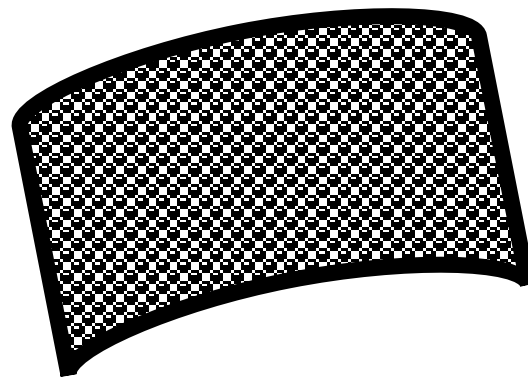

ASSOCIAZIONI DI FIGURE GEOMETRICHE UGUALI

Far associare le figure geometriche uguali.

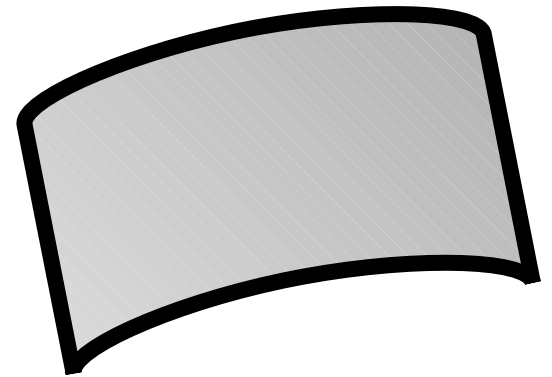
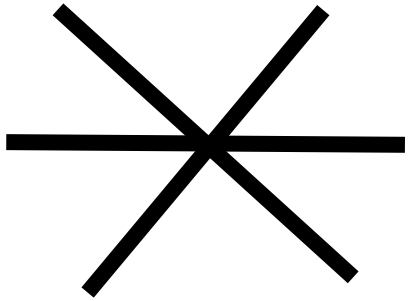
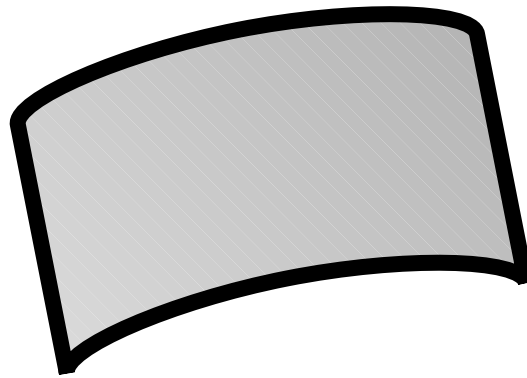

ASSOCIAZIONI DI FIGURE GEOMETRICHE UGUALI

Far associare le figure geometriche uguali.

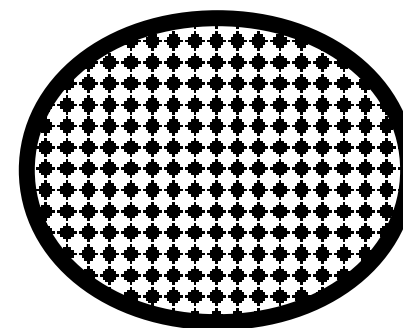
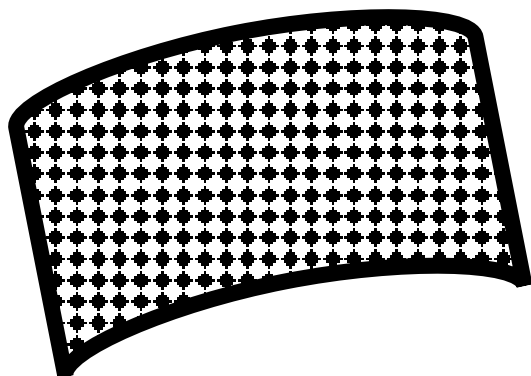
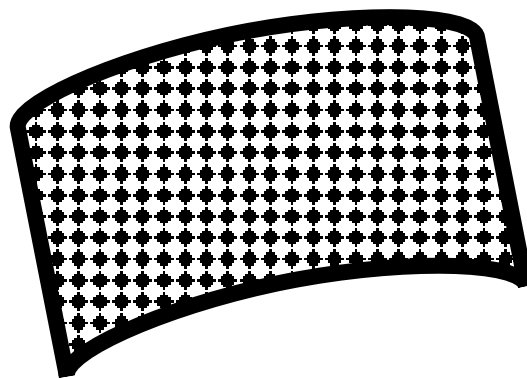

ASSOCIAZIONI DI FIGURE GEOMETRICHE UGUALI

Far associare le figure geometriche uguali.

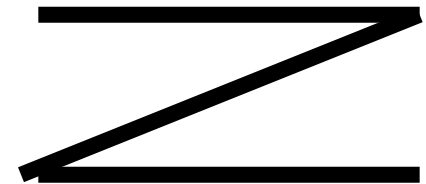
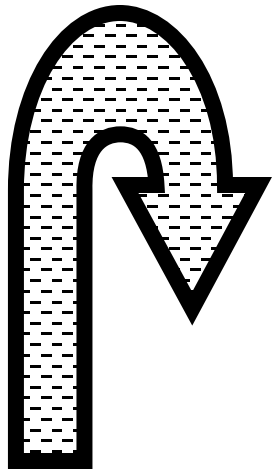
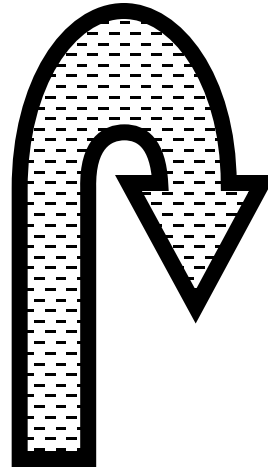

ASSOCIAZIONI DI FIGURE GEOMETRICHE UGUALI

Far associare le figure geometriche uguali.

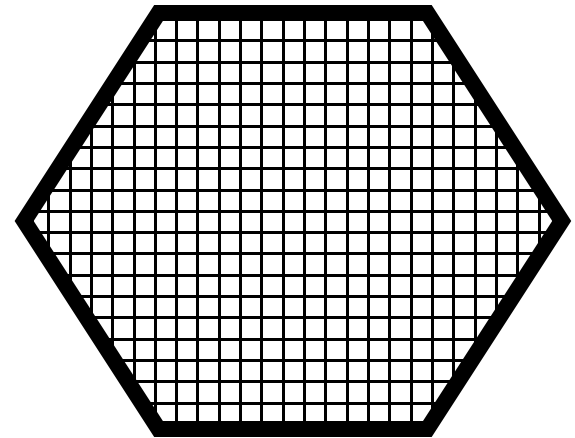
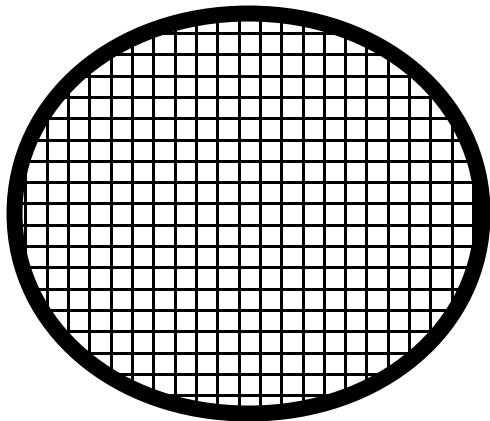
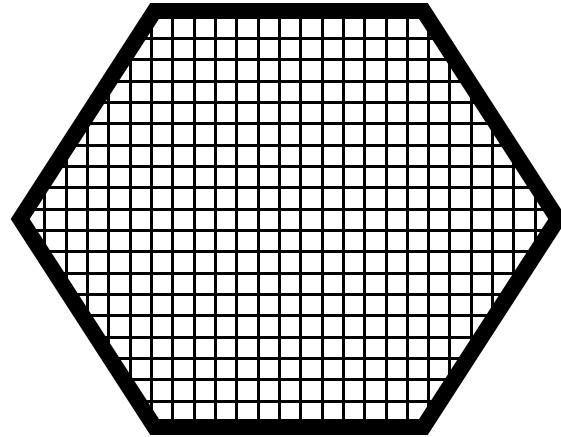

ASSOCIAZIONI DI FIGURE GEOMETRICHE UGUALI

Far associare le figure geometriche uguali.

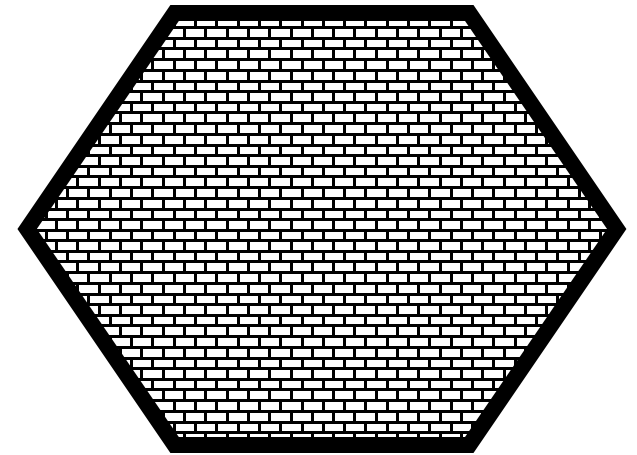
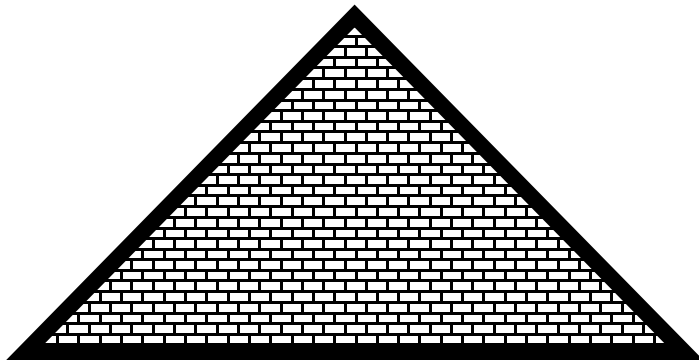
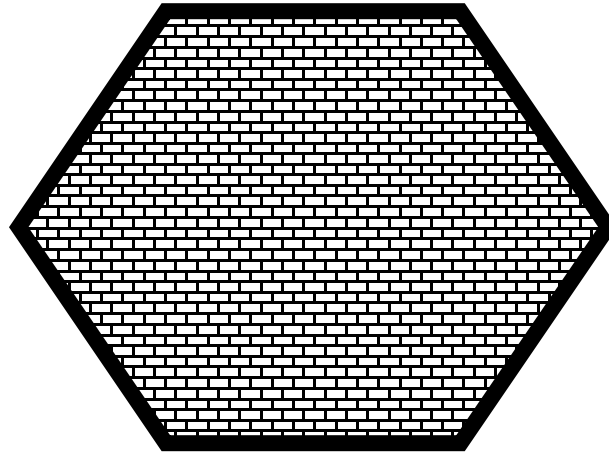

ASSOCIAZIONI DI FIGURE GEOMETRICHE UGUALI

Far associare le figure geometriche uguali.

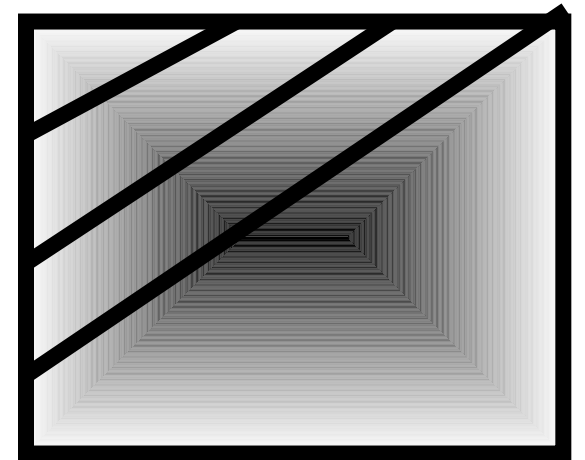
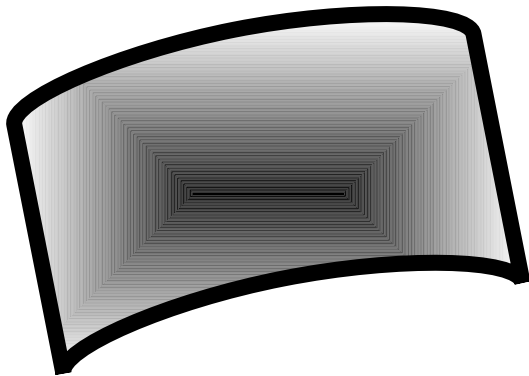
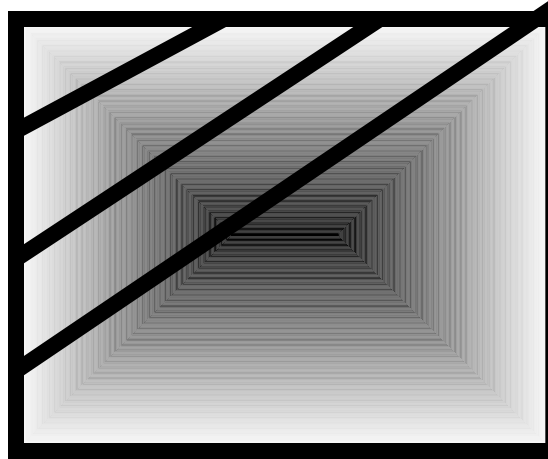

ASSOCIAZIONI DI FIGURE GEOMETRICHE UGUALI

Far associare le figure geometriche uguali.

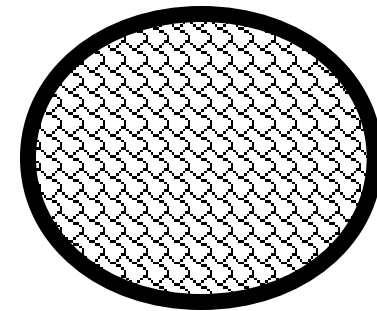
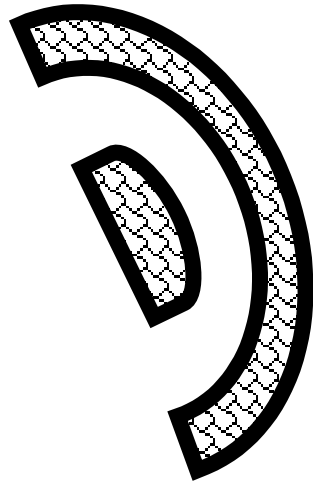
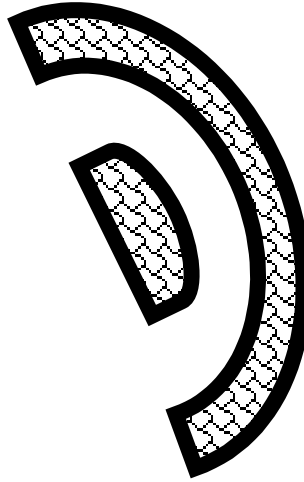

ASSOCIAZIONI DI FIGURE GEOMETRICHE UGUALI

Far associare le figure geometriche uguali.

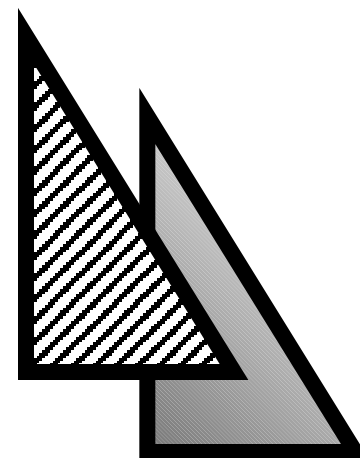
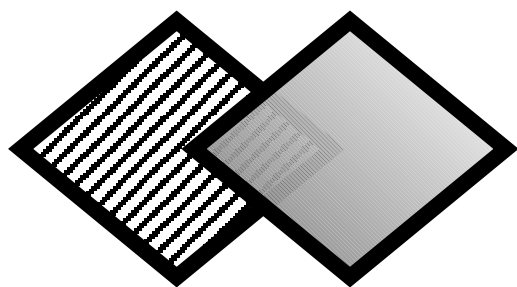
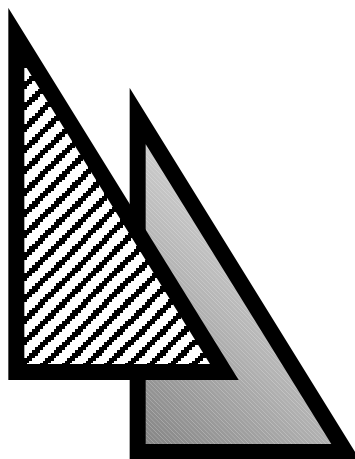

ASSOCIAZIONI DI FIGURE GEOMETRICHE UGUALI

Far associare le figure geometriche uguali.

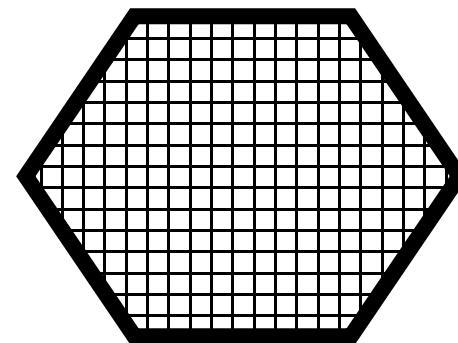
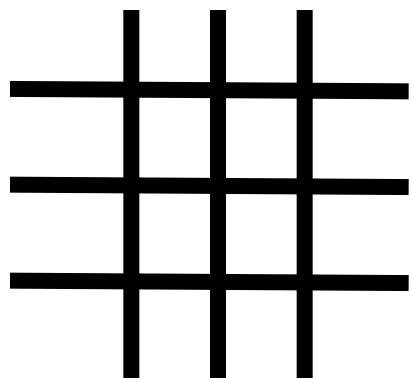
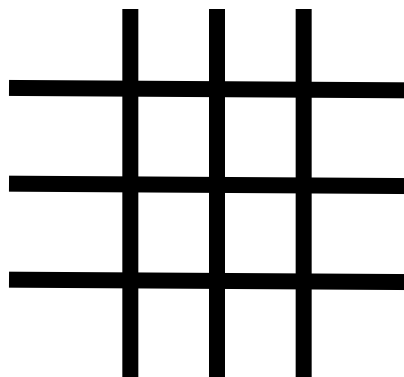

ASSOCIAZIONI DI FIGURE GEOMETRICHE UGUALI

Far associare le figure geometriche uguali.

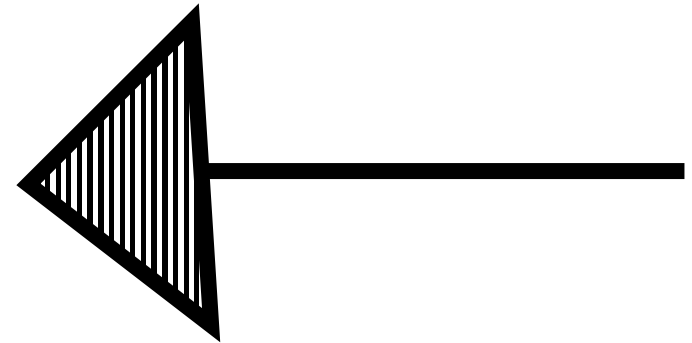
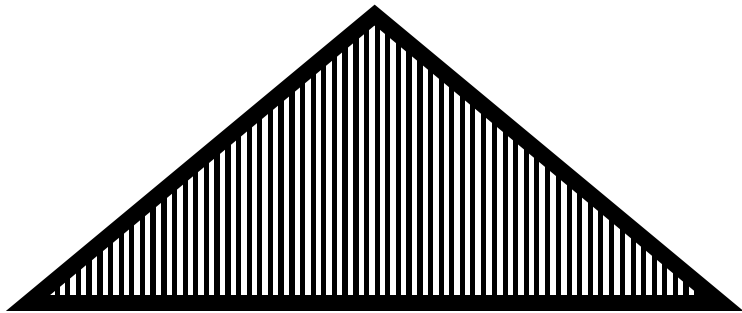
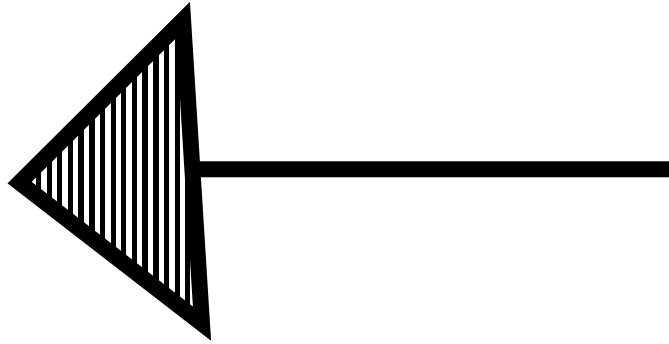

ASSOCIAZIONI DI FIGURE GEOMETRICHE UGUALI

Far associare le figure geometriche uguali.

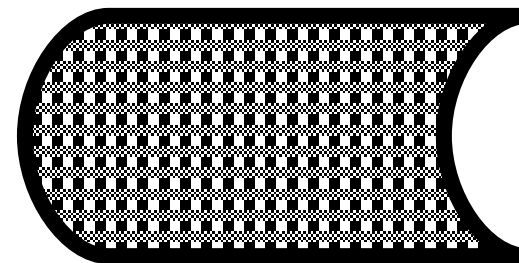
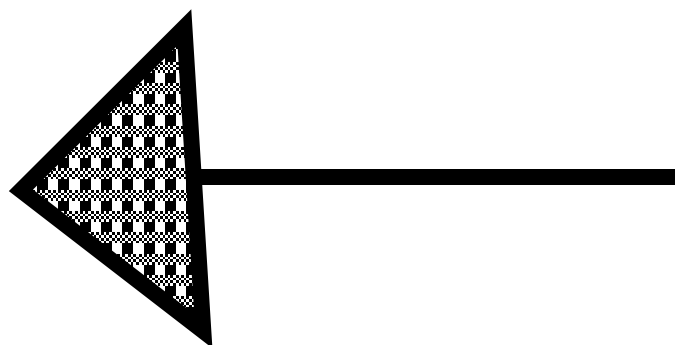
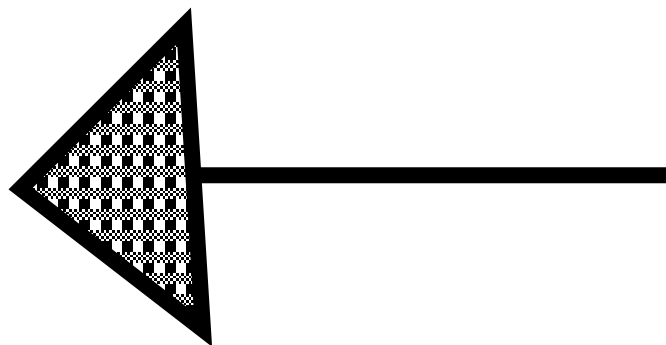

ASSOCIAZIONI DI FIGURE GEOMETRICHE UGUALI

Far associare le figure geometriche uguali.

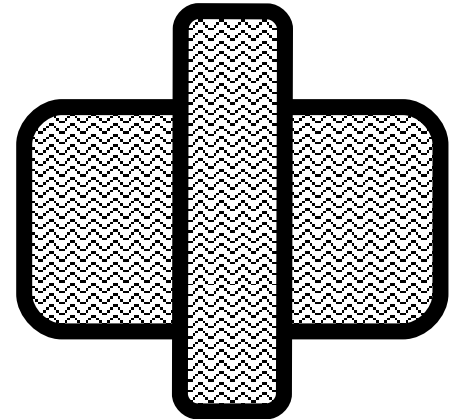
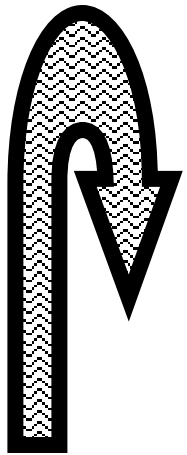
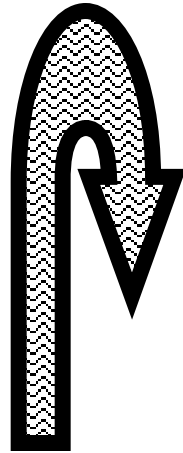

ASSOCIAZIONI DI FIGURE GEOMETRICHE UGUALI

Far associare le figure geometriche uguali.

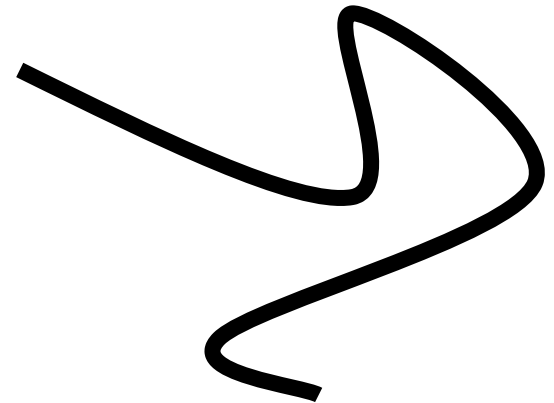
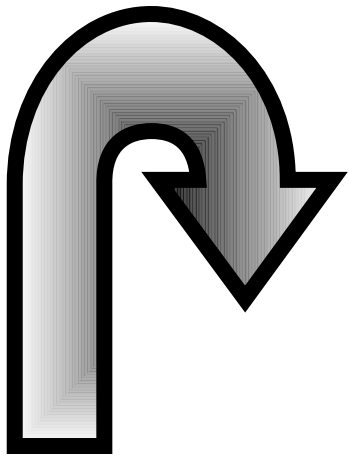
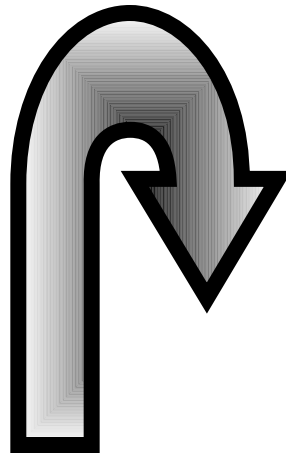

ASSOCIAZIONI DI FIGURE GEOMETRICHE UGUALI

Far associare le figure geometriche uguali.

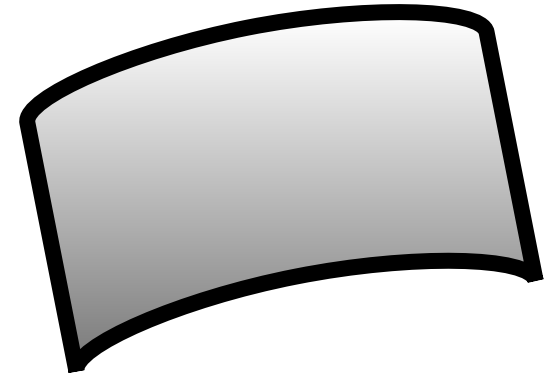
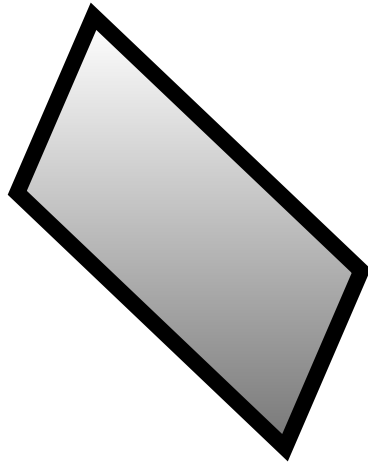
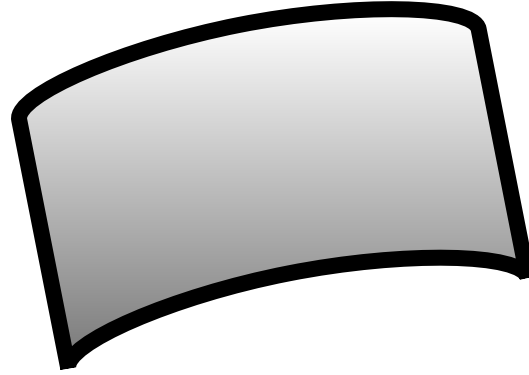

ASSOCIAZIONI DI FIGURE GEOMETRICHE UGUALI

Far associare le figure geometriche uguali.

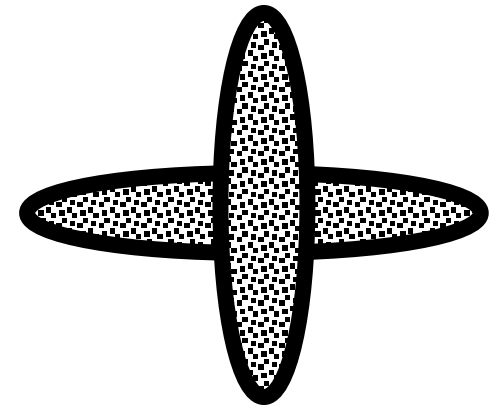
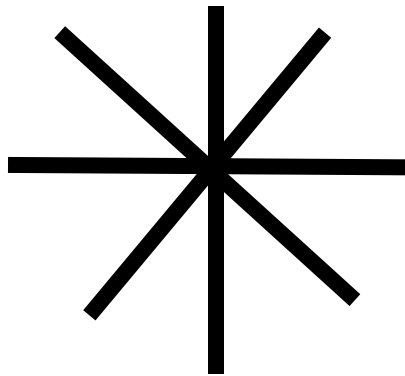
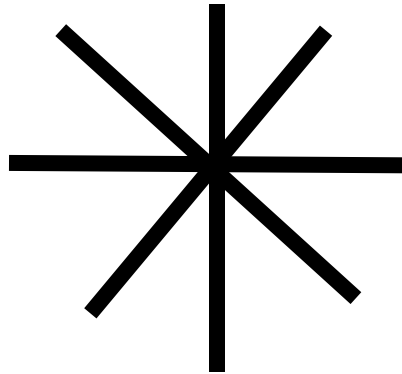

ASSOCIAZIONI DI FIGURE GEOMETRICHE UGUALI

Far associare le figure geometriche uguali.

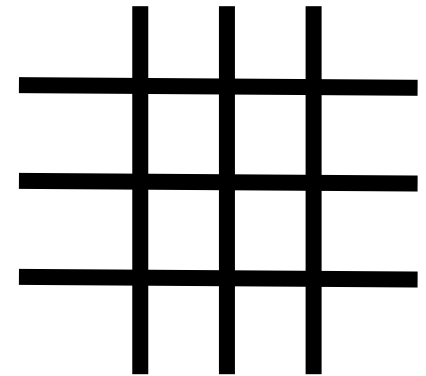
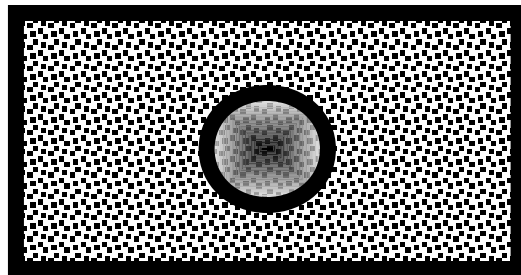
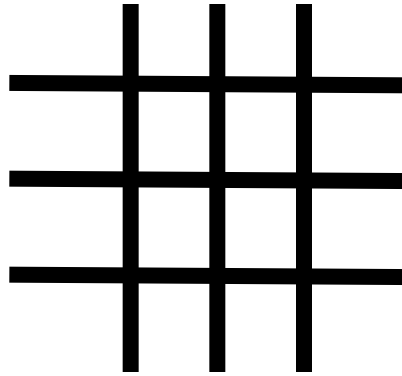

ASSOCIAZIONI DI FIGURE GEOMETRICHE UGUALI

Far associare le figure geometriche uguali.

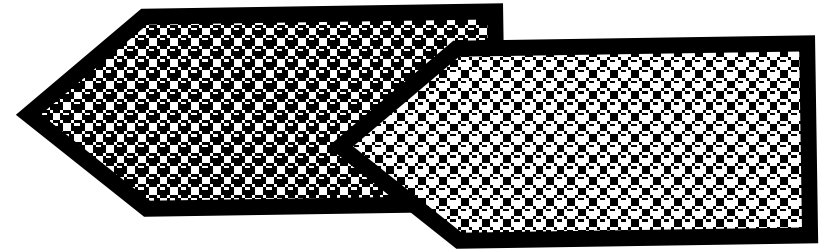
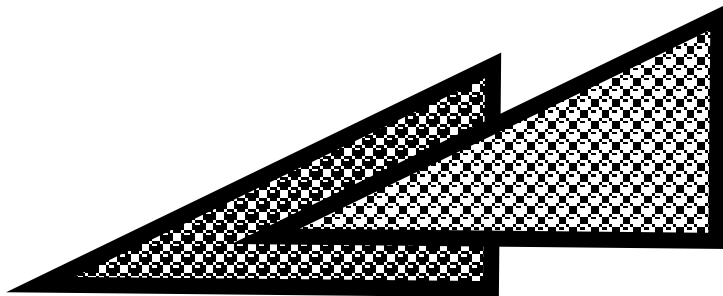
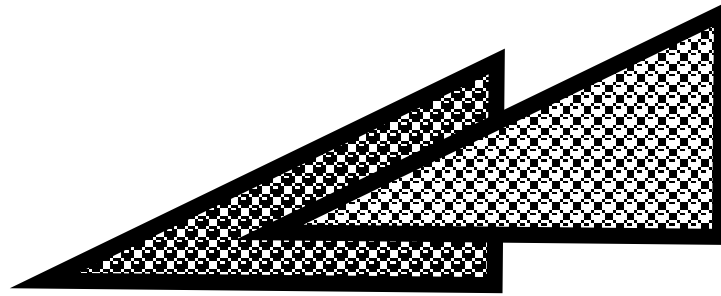

ASSOCIAZIONI DI FIGURE GEOMETRICHE UGUALI

Far associare le figure geometriche uguali.

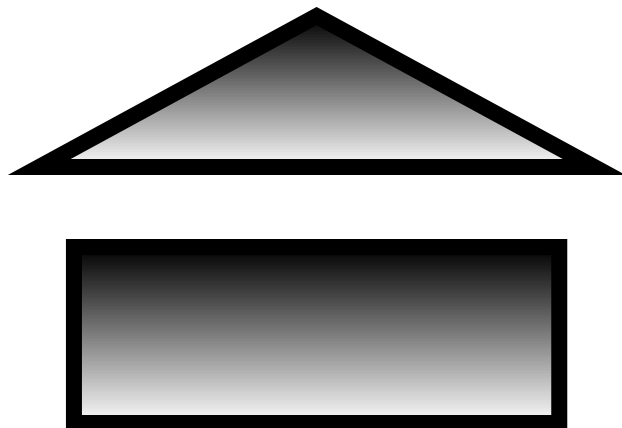

ASSOCIAZIONI DI FIGURE GEOMETRICHE UGUALI

Far associare le figure geometriche uguali.

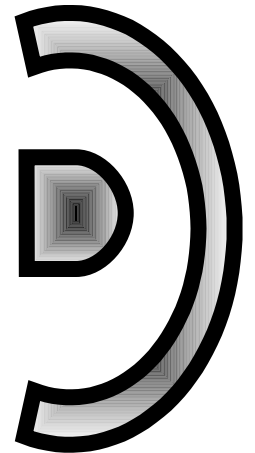
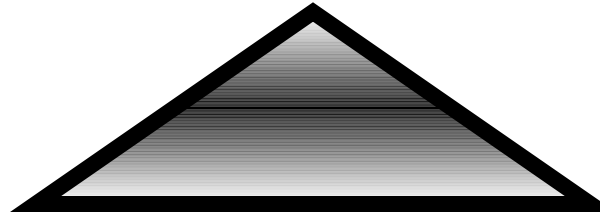
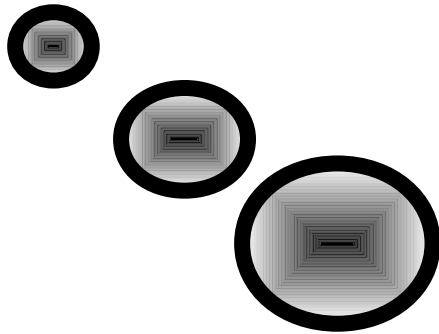
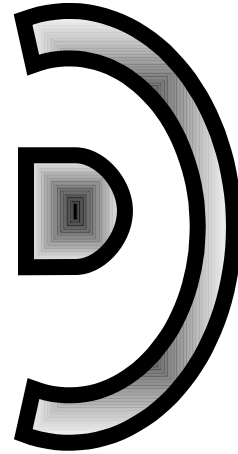

ASSOCIAZIONI DI FIGURE GEOMETRICHE UGUALI

Far associare le figure geometriche uguali.

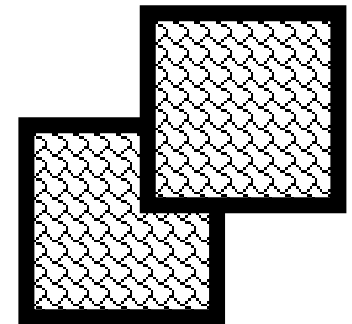
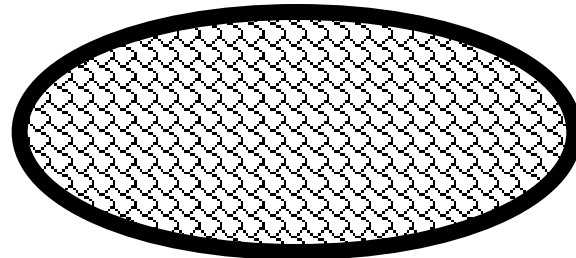
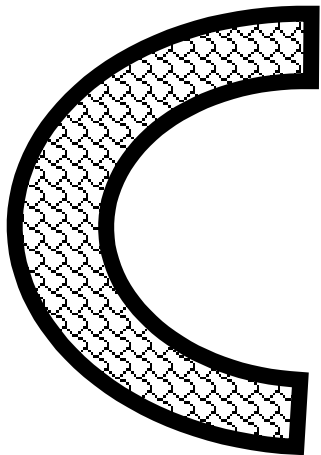
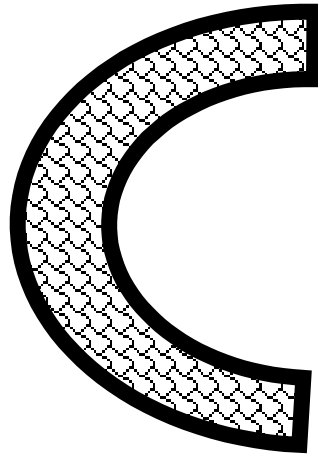

ASSOCIAZIONI DI FIGURE GEOMETRICHE UGUALI

Far associare le figure geometriche uguali.

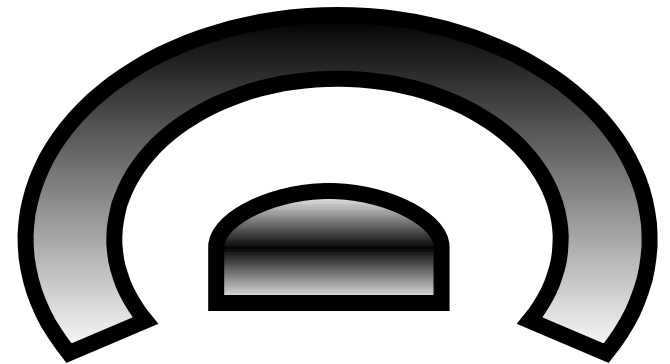
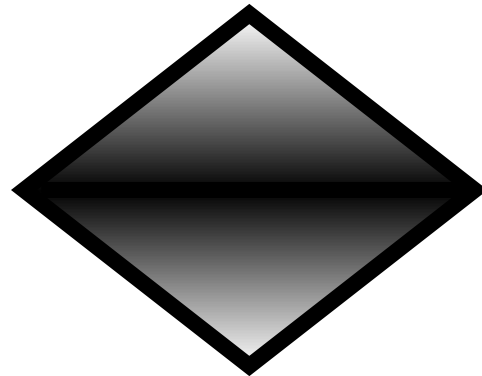
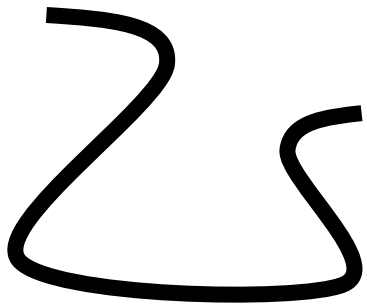
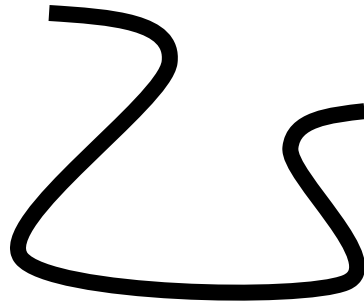

ASSOCIAZIONI DI FIGURE GEOMETRICHE UGUALI

Far associare le figure geometriche uguali.

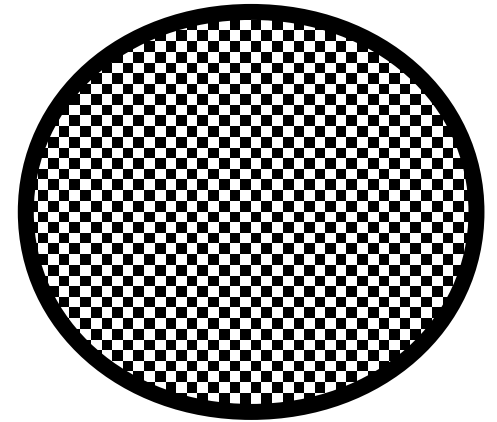
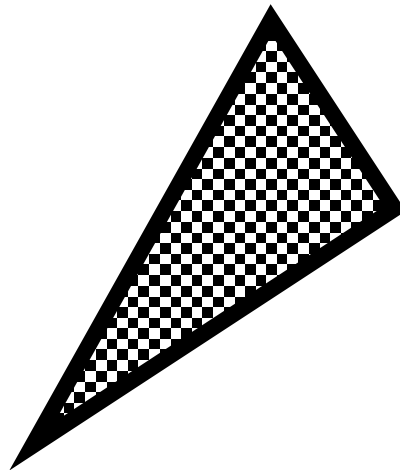
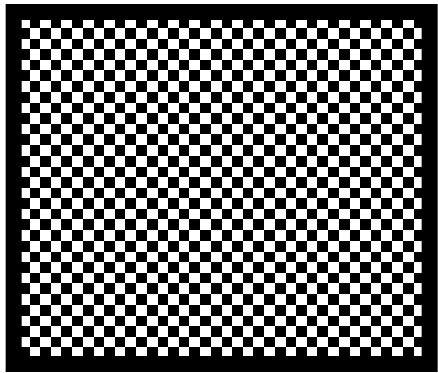
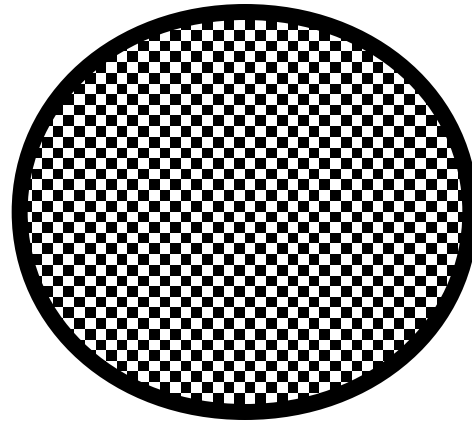

ASSOCIAZIONI DI FIGURE GEOMETRICHE UGUALI

Far associare le figure geometriche uguali.

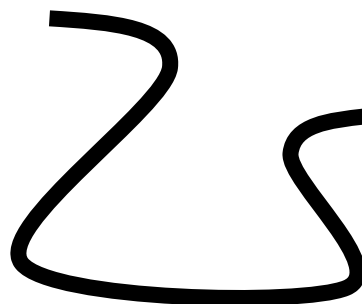
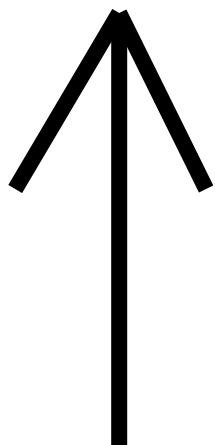
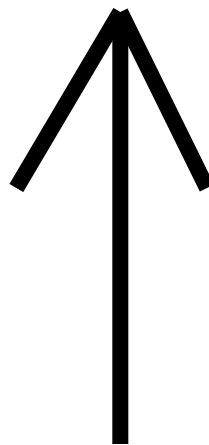

ASSOCIAZIONI DI FIGURE GEOMETRICHE UGUALI

Far associare le figure geometriche uguali.

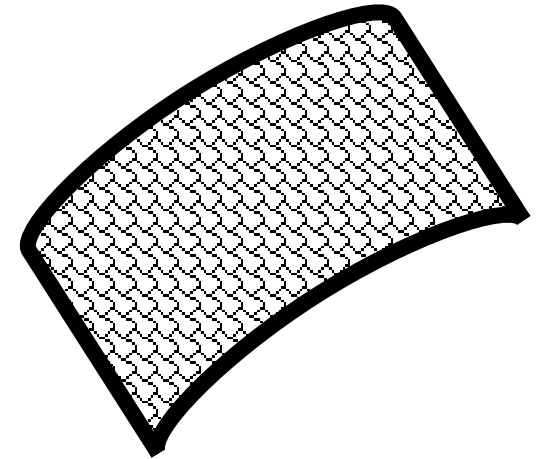
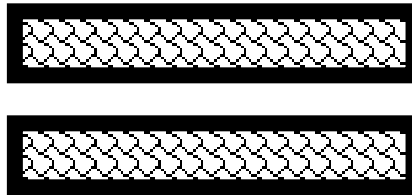
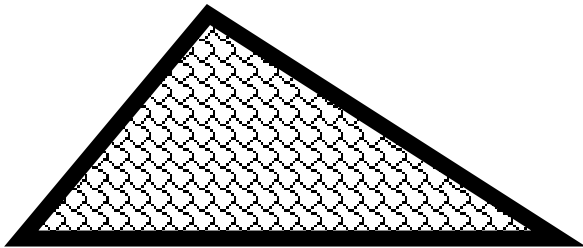
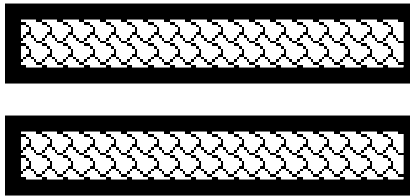

ASSOCIAZIONI DI FIGURE GEOMETRICHE UGUALI

Far associare le figure geometriche uguali.

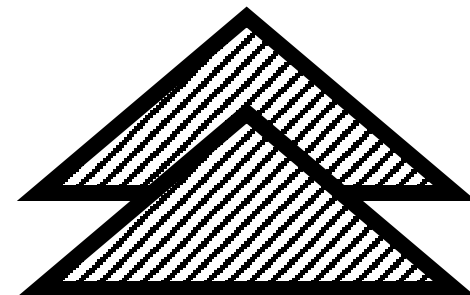
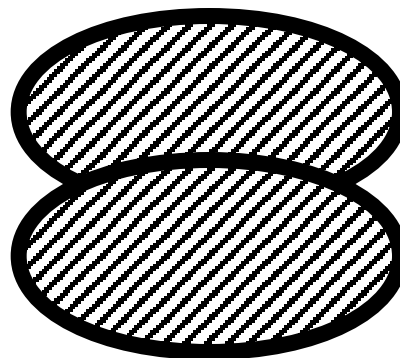
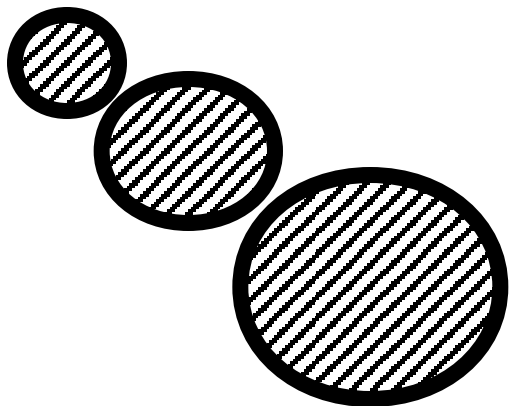
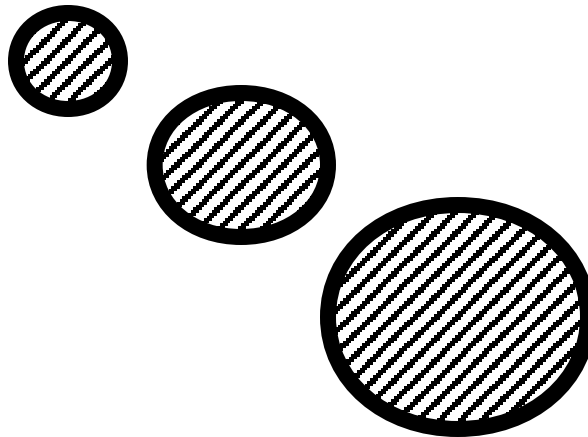

ASSOCIAZIONI DI FIGURE GEOMETRICHE UGUALI

Far associare le figure geometriche uguali.

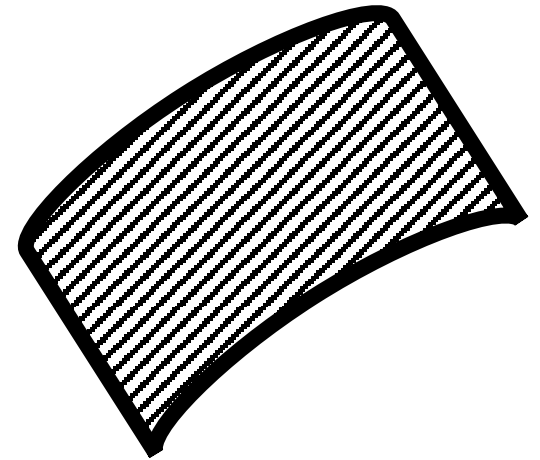
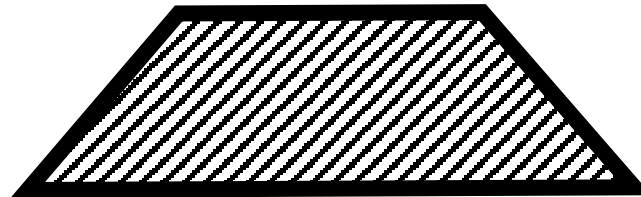
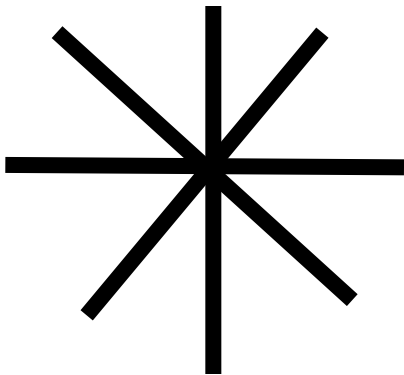
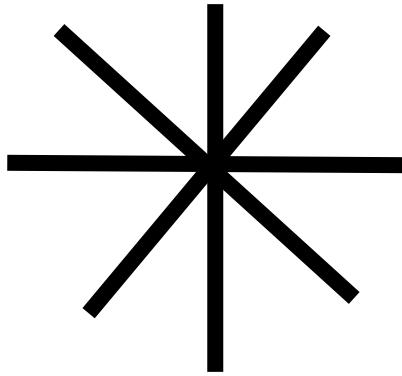

ASSOCIAZIONI DI FIGURE GEOMETRICHE UGUALI

Far associare le figure geometriche uguali.

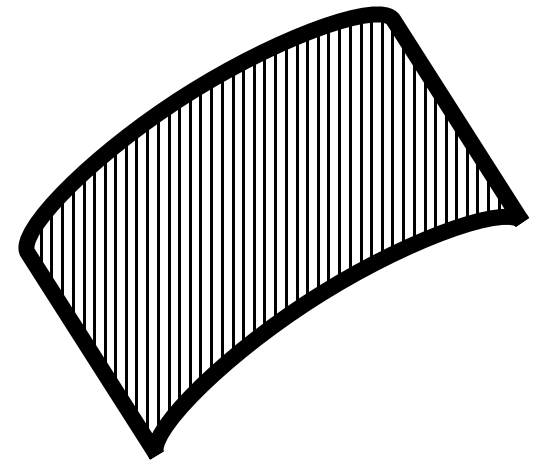
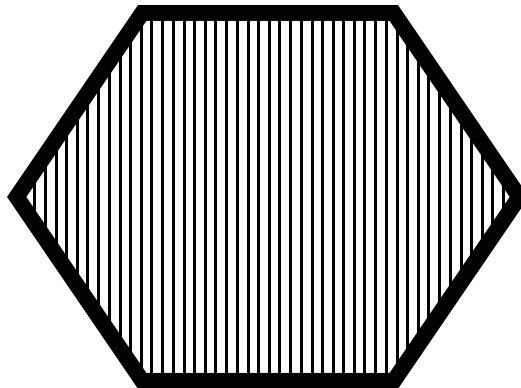
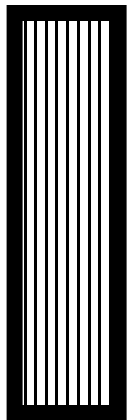
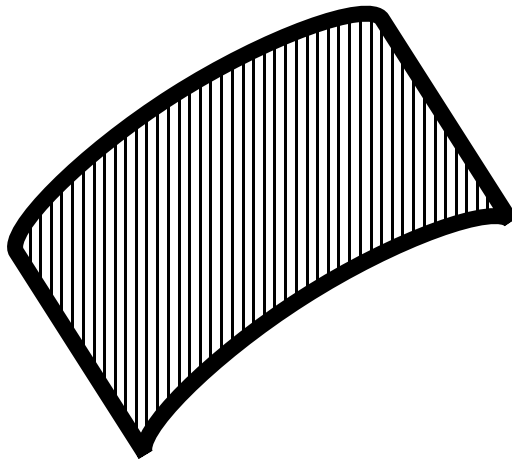

ASSOCIAZIONI DI FIGURE GEOMETRICHE UGUALI

Far associare le figure geometriche uguali.

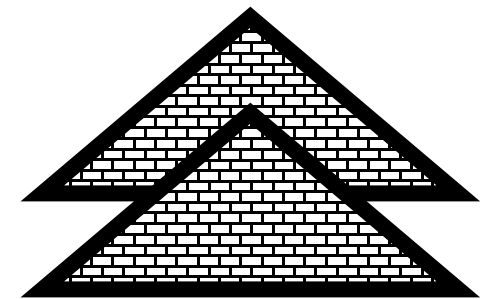
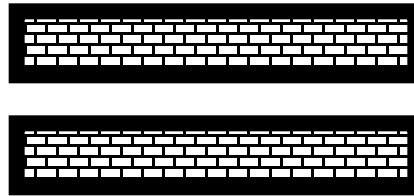
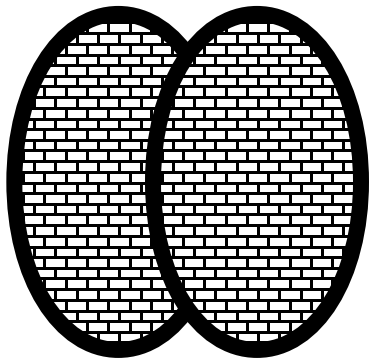
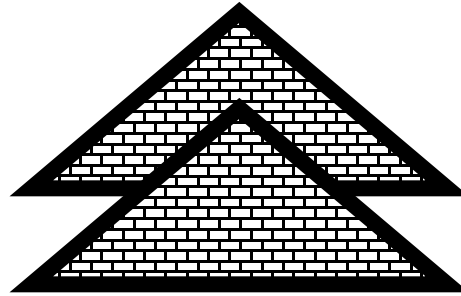

ASSOCIAZIONI DI FIGURE GEOMETRICHE UGUALI

Far associare le figure geometriche uguali.

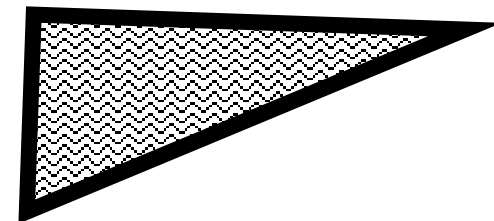
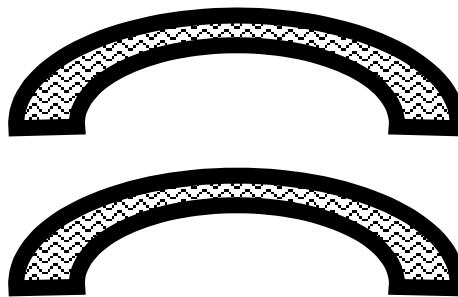
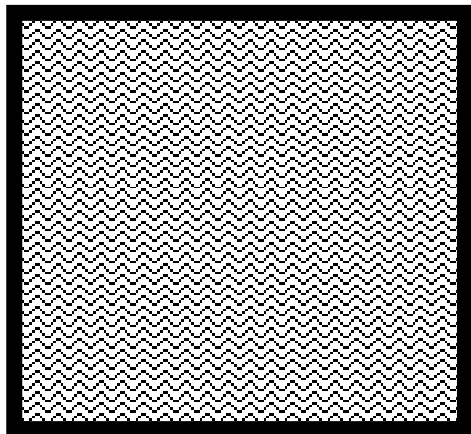
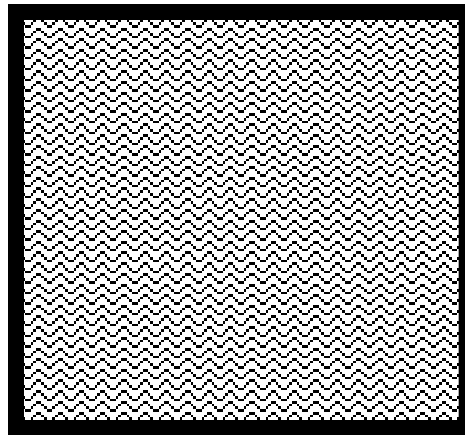

ASSOCIAZIONI DI FIGURE GEOMETRICHE UGUALI

Far associare le figure geometriche uguali.

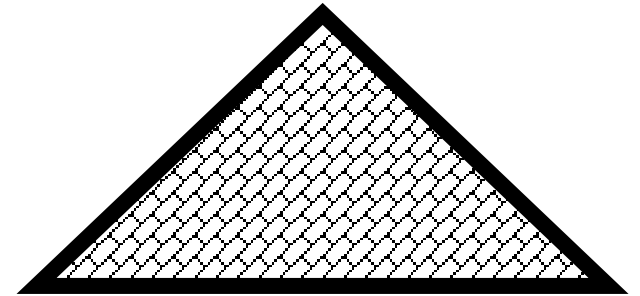
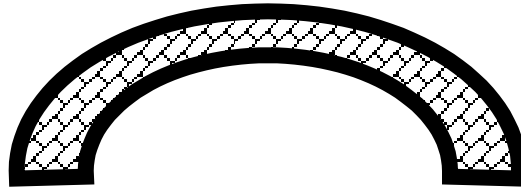
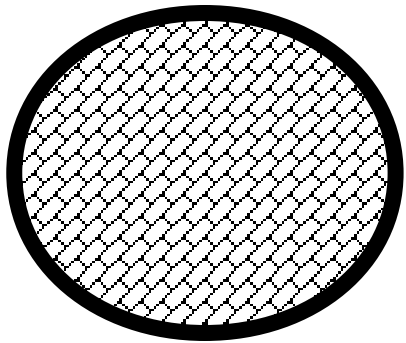
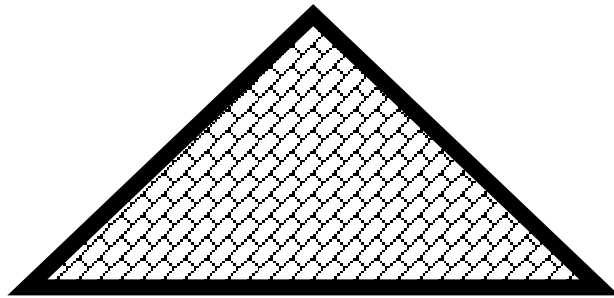

ASSOCIAZIONI DI FIGURE GEOMETRICHE UGUALI

Far associare le figure geometriche uguali.

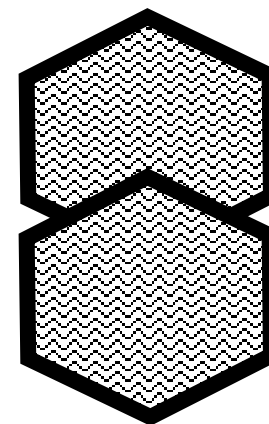
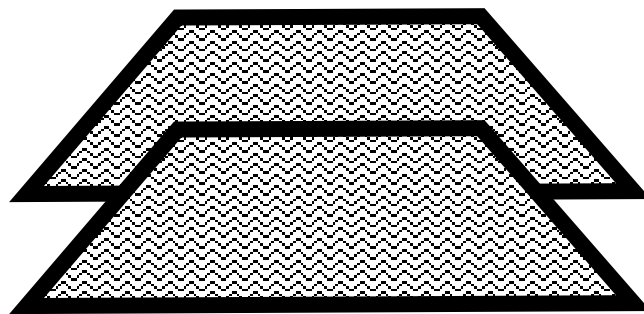
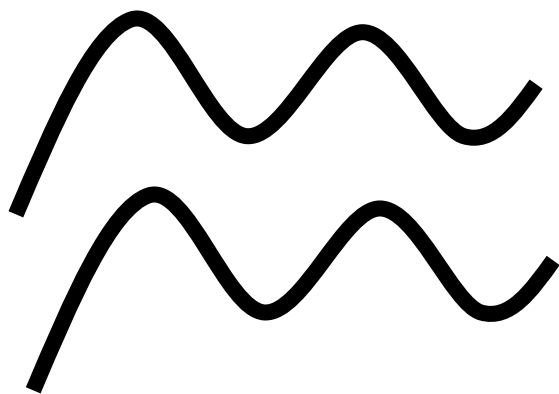
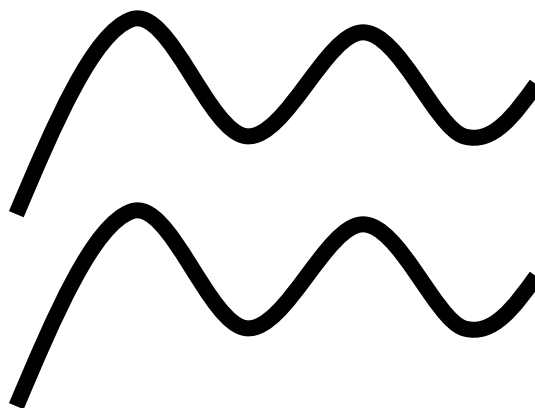

ASSOCIAZIONI DI FIGURE GEOMETRICHE UGUALI

Far associare le figure geometriche uguali.

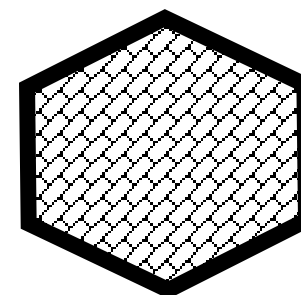
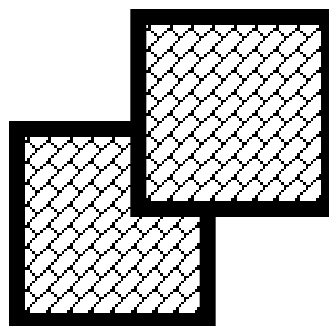
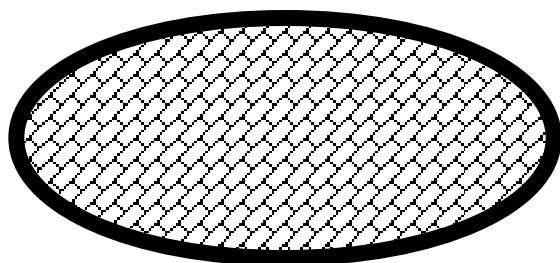
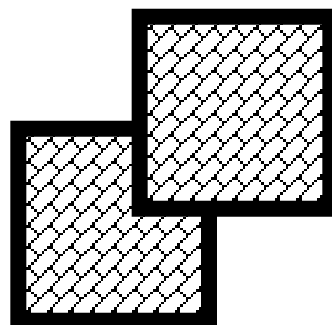

ASSOCIAZIONI DI FIGURE GEOMETRICHE UGUALI

Far associare le figure geometriche uguali.

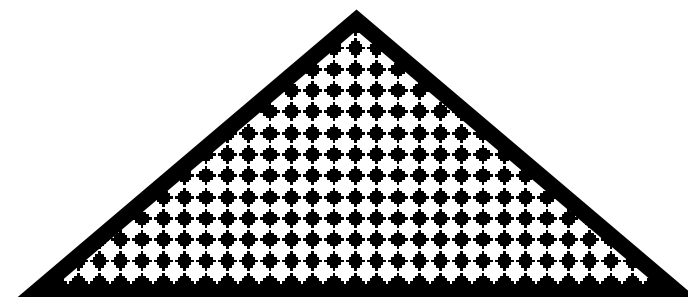
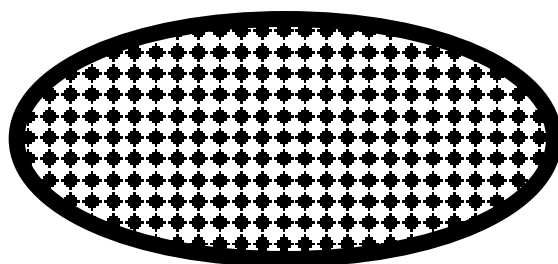
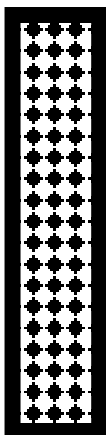
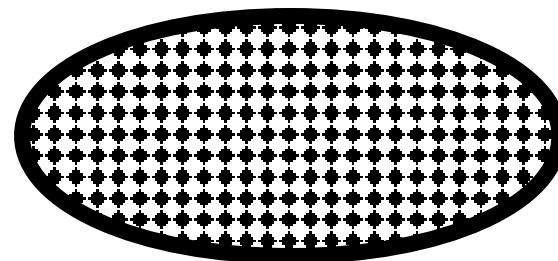
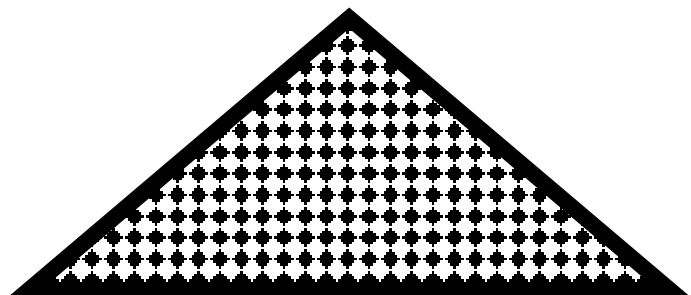

ASSOCIAZIONI DI FIGURE GEOMETRICHE UGUALI

Far associare le figure geometriche uguali.

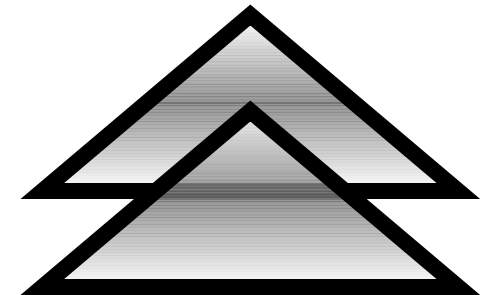
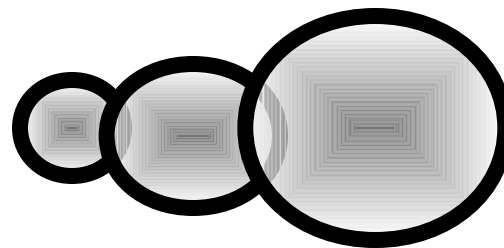
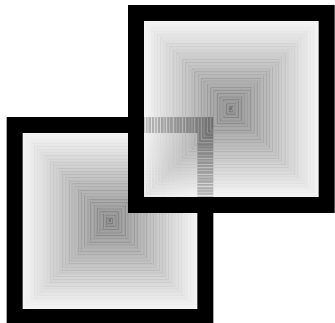
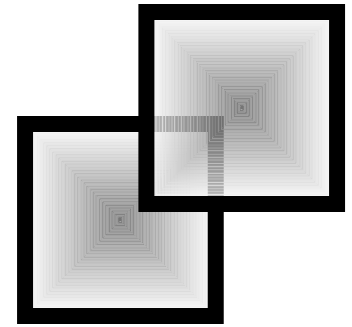
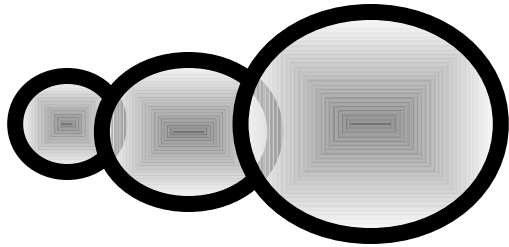

ASSOCIAZIONI DI FIGURE GEOMETRICHE UGUALI

Far associare le figure geometriche uguali.

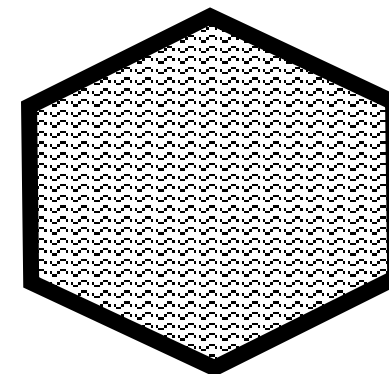
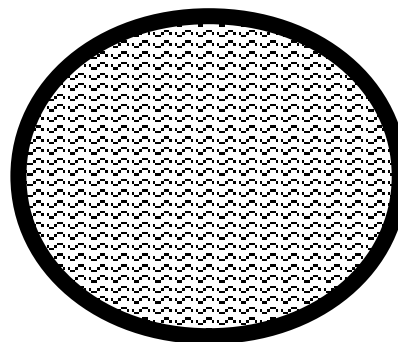
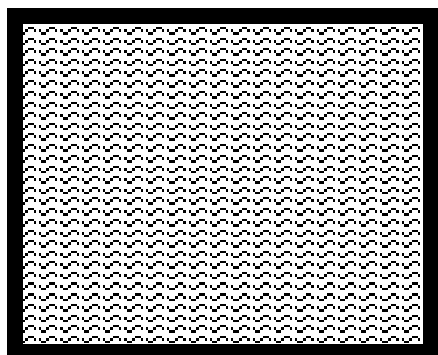
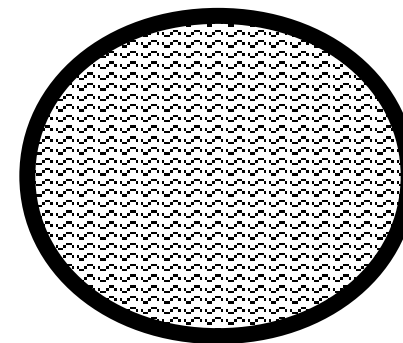
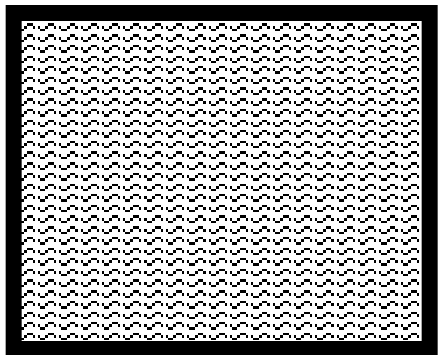

ASSOCIAZIONI DI FIGURE GEOMETRICHE UGUALI

Far associare le figure geometriche uguali.

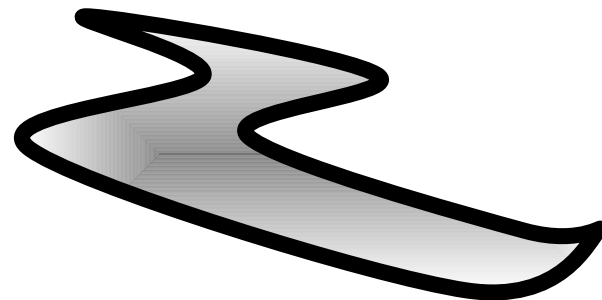
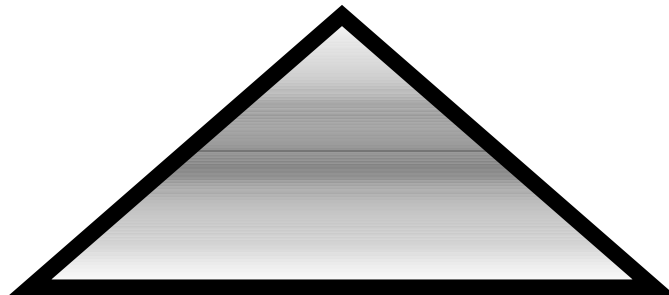
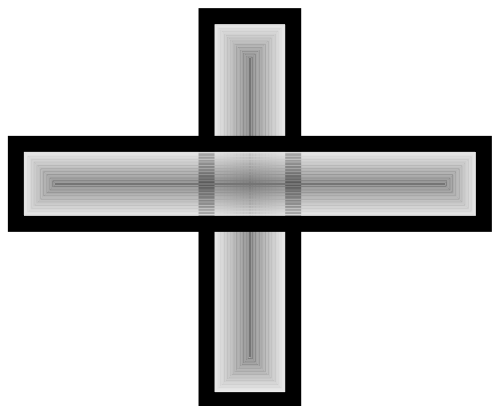
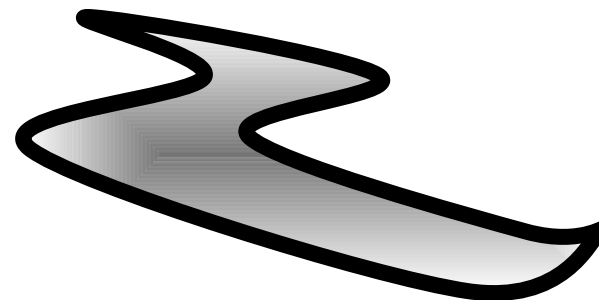
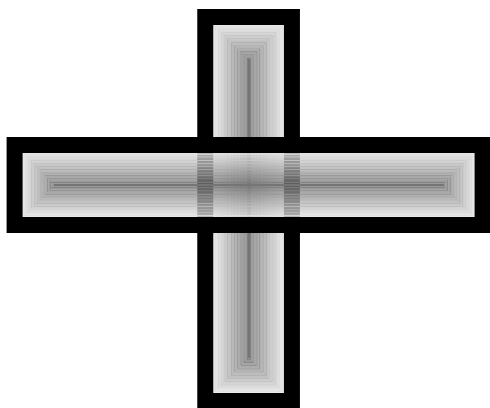

ASSOCIAZIONI DI FIGURE GEOMETRICHE UGUALI

Far associare le figure geometriche uguali.

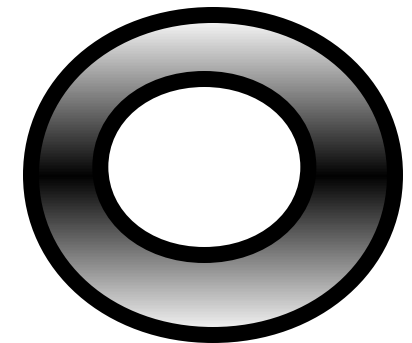
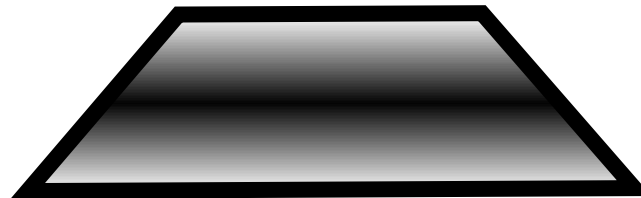
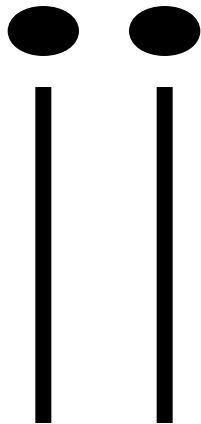
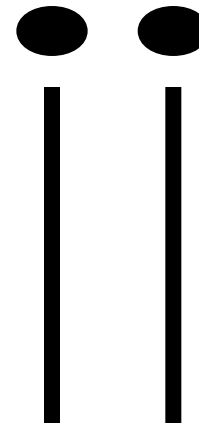
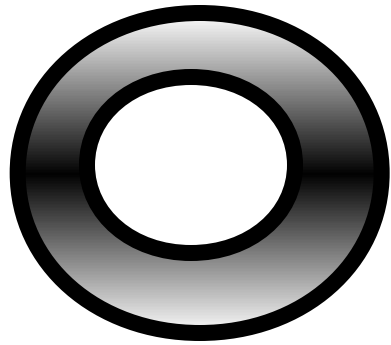

ASSOCIAZIONI DI FIGURE GEOMETRICHE UGUALI

Far associare le figure geometriche uguali.

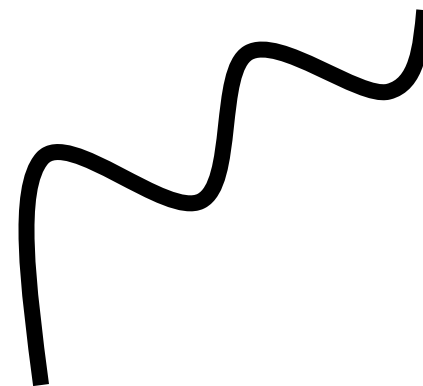
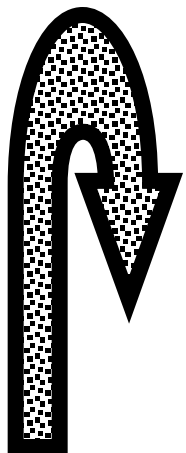
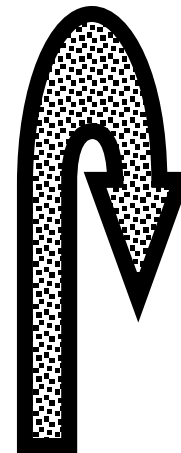

ASSOCIAZIONI DI FIGURE GEOMETRICHE UGUALI

Far associare le figure geometriche uguali.

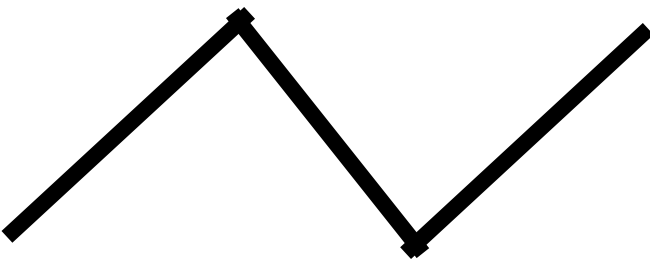
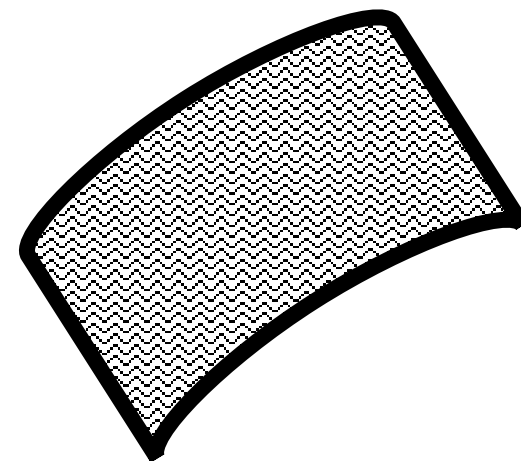
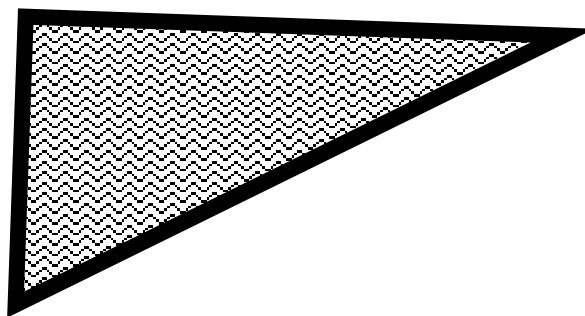
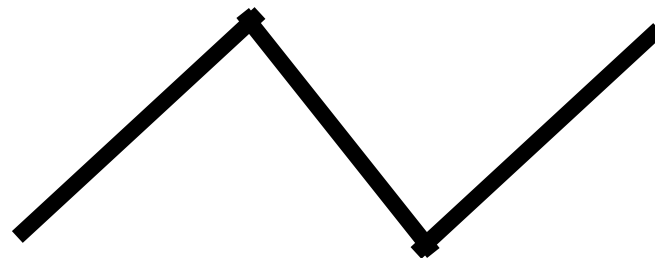
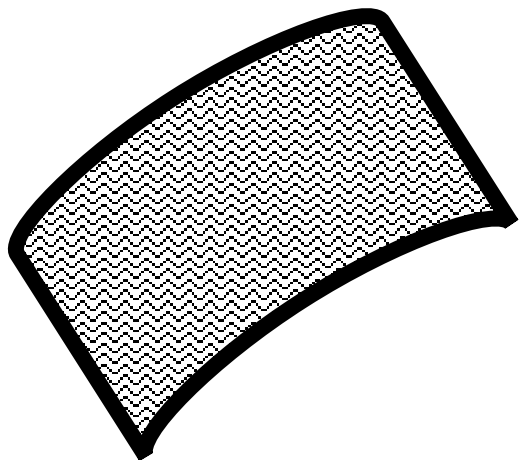

ASSOCIAZIONI DI FIGURE GEOMETRICHE UGUALI

Far associare le figure geometriche uguali.

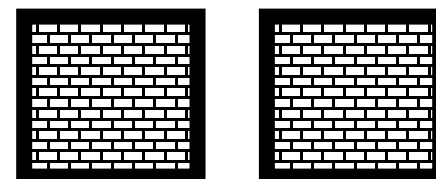
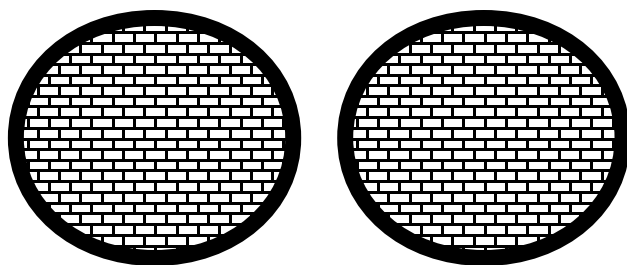
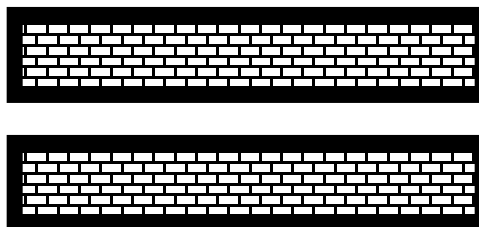
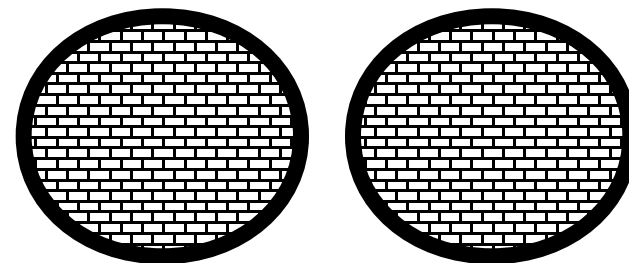
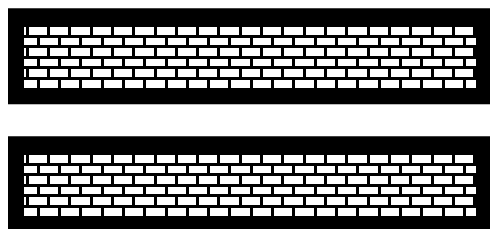

ASSOCIAZIONI DI FIGURE GEOMETRICHE UGUALI

Far associare le figure geometriche uguali.

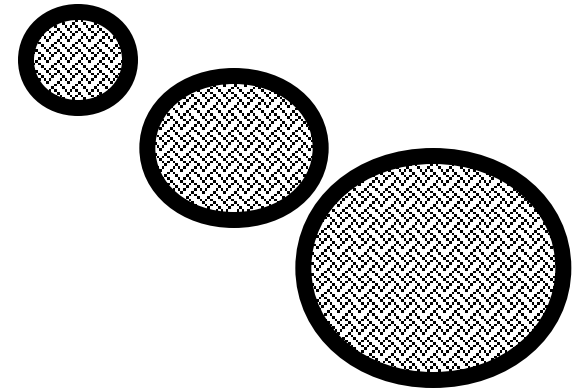
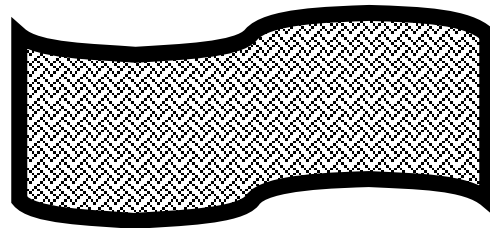
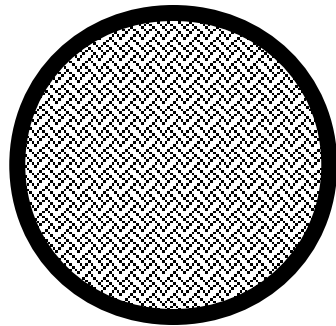
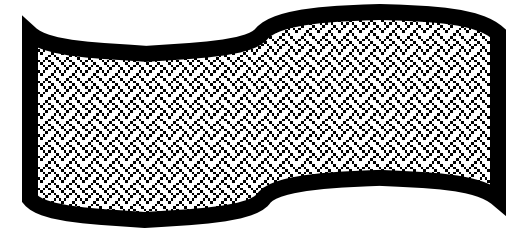
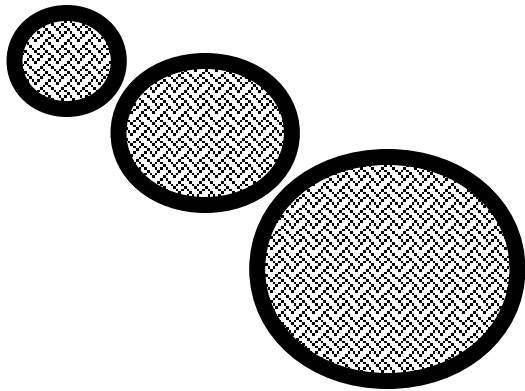

ASSOCIAZIONI DI FIGURE GEOMETRICHE UGUALI

Far associare le figure geometriche uguali.

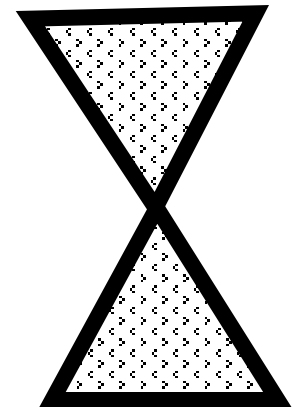
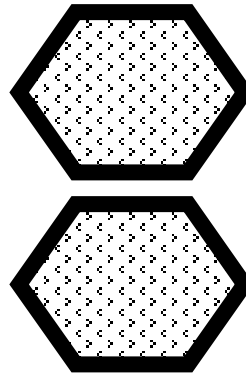
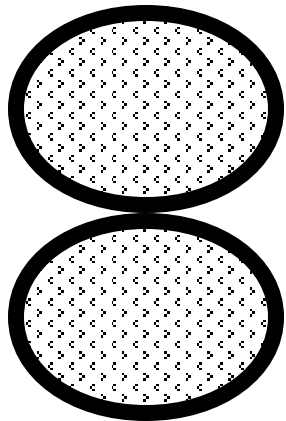
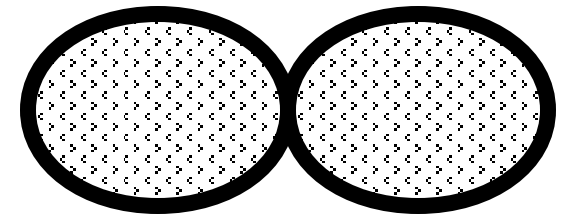
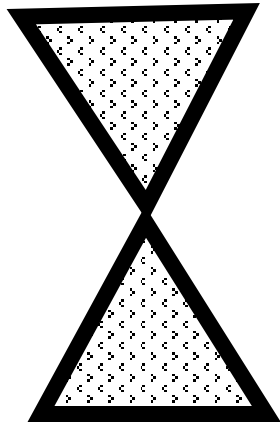

ASSOCIAZIONI DI FIGURE GEOMETRICHE UGUALI

Far associare le figure geometriche uguali.

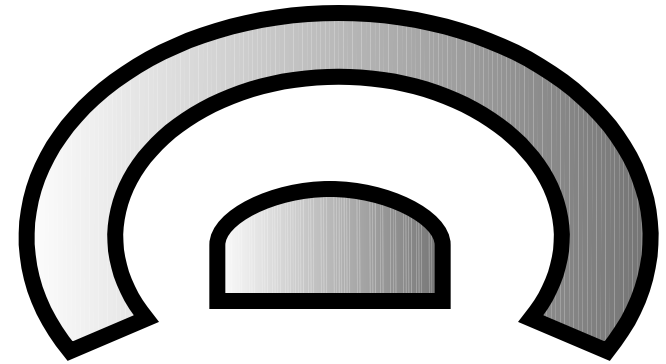
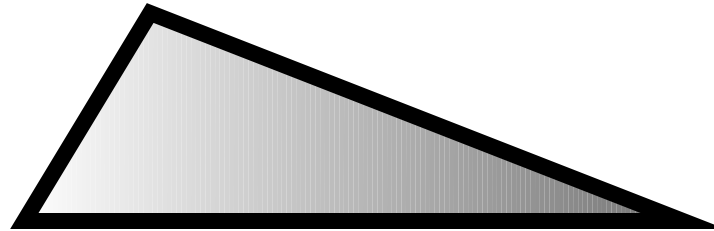
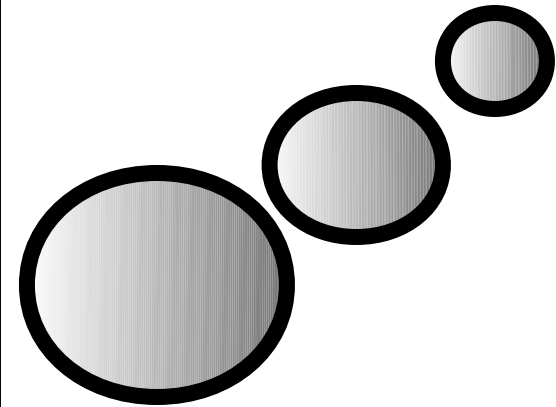
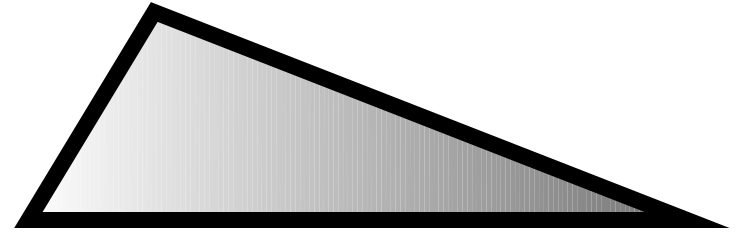
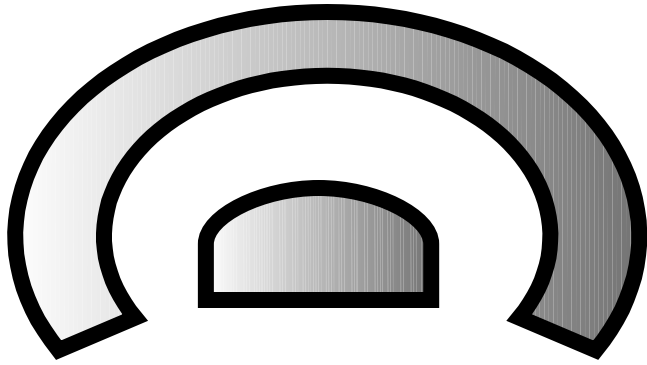

ASSOCIAZIONI DI FIGURE GEOMETRICHE UGUALI

Far associare le figure geometriche uguali.

“ VOGLIA DI CRESCERE ”

PROGRAMMA BASE PER LO SVILUPPO LOGICO E COGNITIVO

ASSOCIAZIONI DI IMMAGINI IN PARTE CANCELLATE

ASSOCIAZIONI DI FIGURE IN PARTE CANCELLATE

Abbiamo inserito nel nostro programma l'associazione di figure in parte cancellate in quanto è importante stimolare e sviluppare i centri deputati al riconoscimento visivo anche se l'immagine esaminata dovesse presentarsi confusa o incompleta. Questi centri, presenti nell'emisfero sinistro, sono essenziali al riconoscimento delle parole e delle lettere nella scrittura corsiva che è in parte diversa da una persona all'altra

UTILIZZAZIONE

Per utilizzare tali schede basta indicare al bambino l'immagine presente nella parte alta della scheda chiedendo di ricercarla nella parte bassa.

ETA' DI RIFERIMENTO

Due anni nello sviluppo logico.

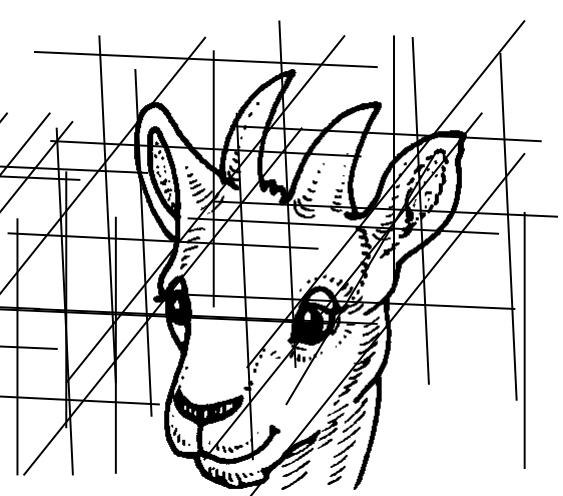
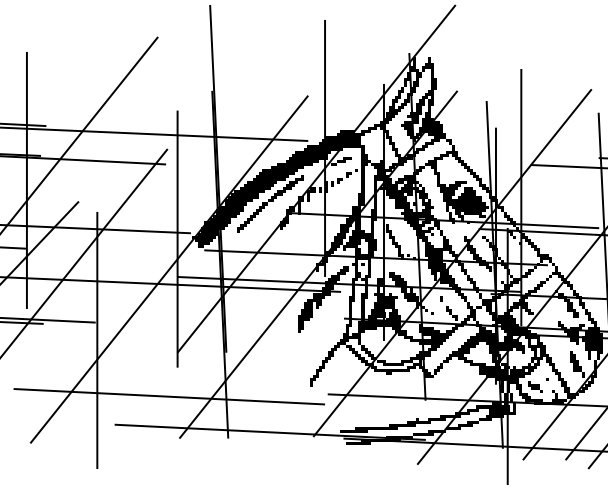
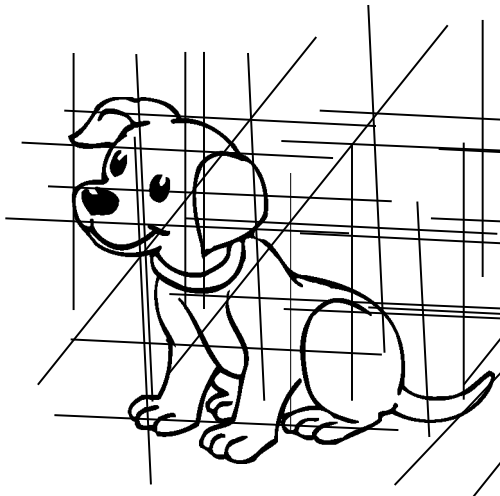
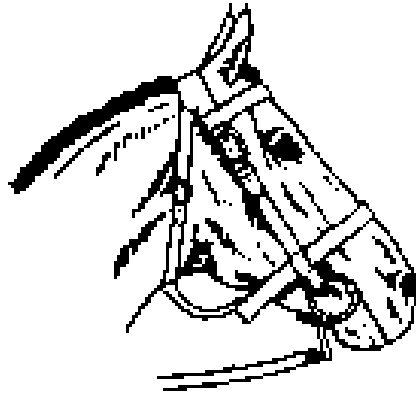
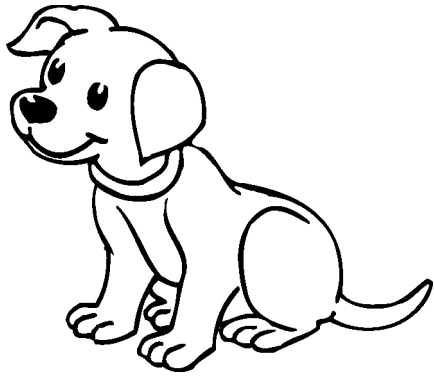

ASSOCIAZIONI LOGICHE

Far associare le immagini secondo un legame logico.

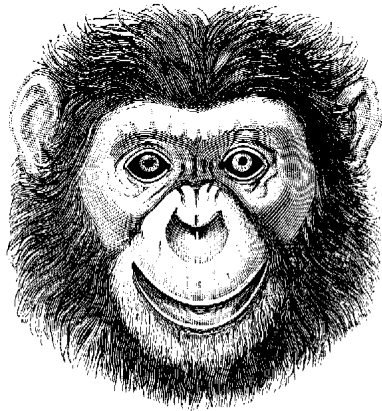

Monkey face

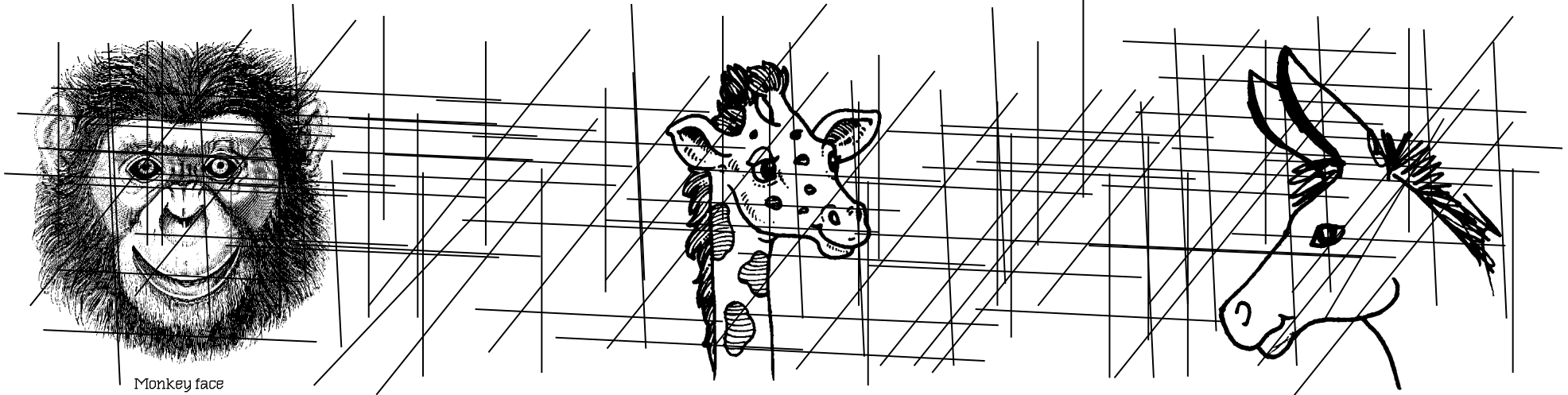

Monkey face

ASSOCIAZIONI LOGICHE

Far associare le immagini secondo un legame logico.

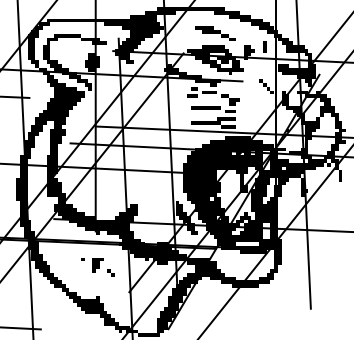
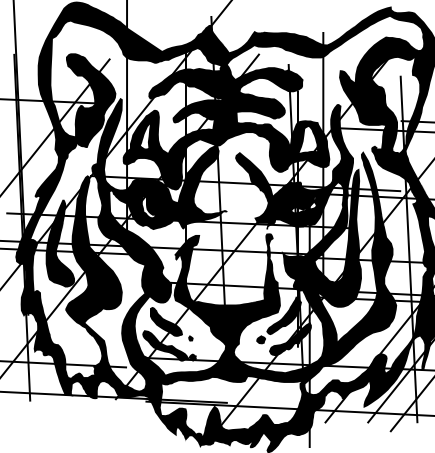
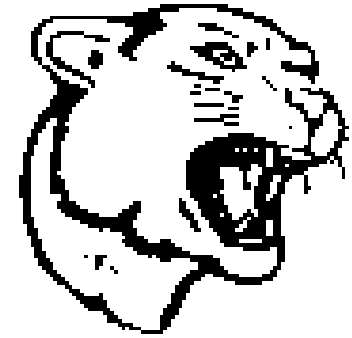

ASSOCIAZIONI LOGICHE

Far associare le immagini secondo un legame logico.

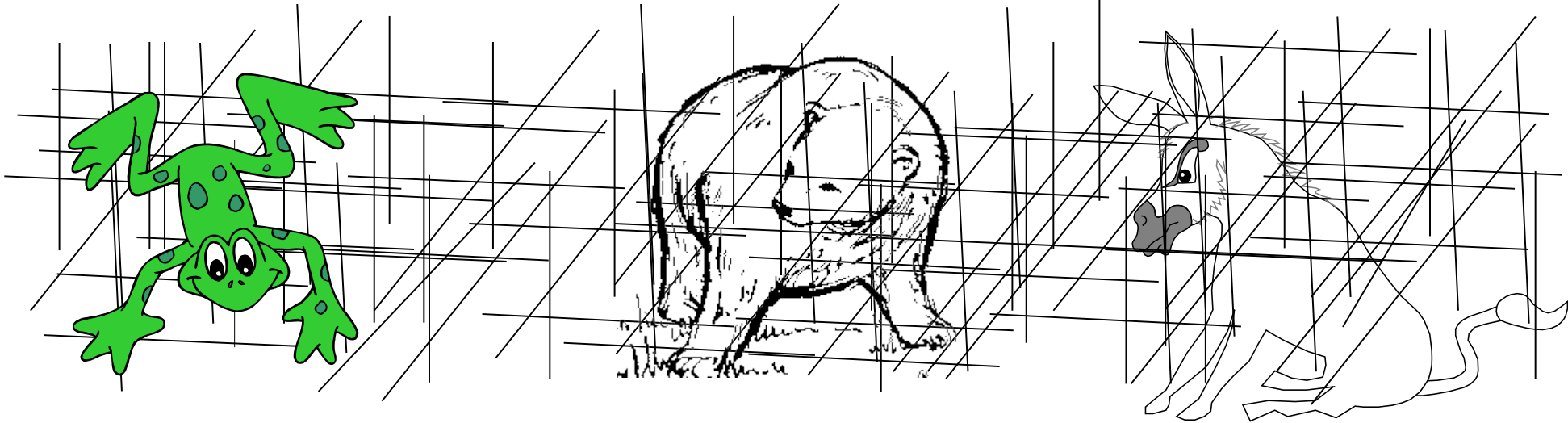
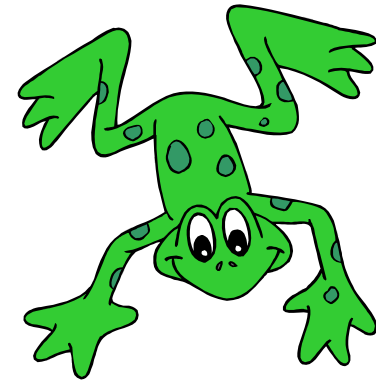
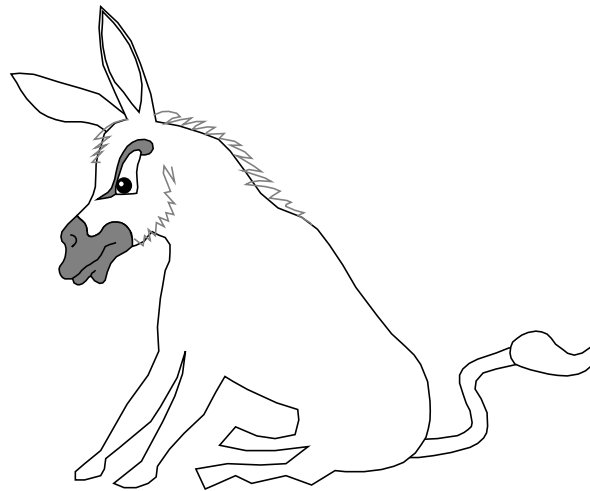
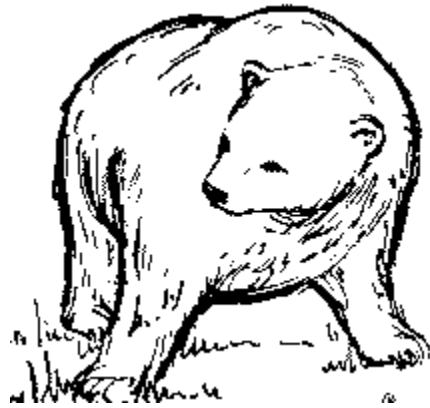

ASSOCIAZIONI LOGICHE

Far associare le immagini secondo un legame logico.

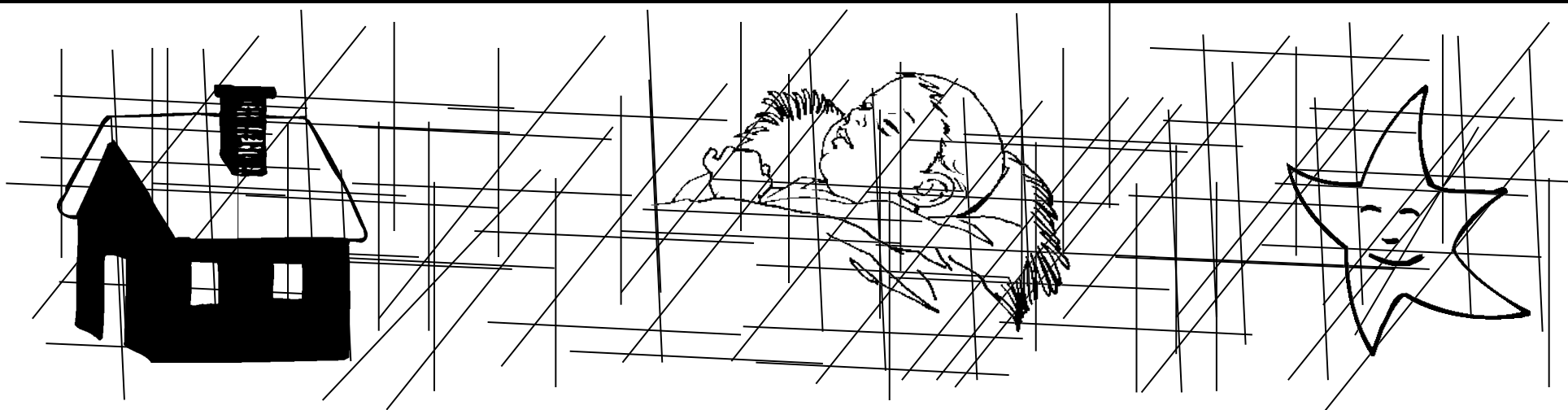
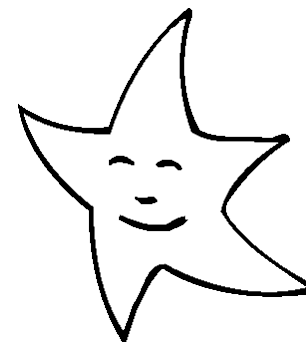

ASSOCIAZIONI LOGICHE

Far associare le immagini secondo un legame logico.

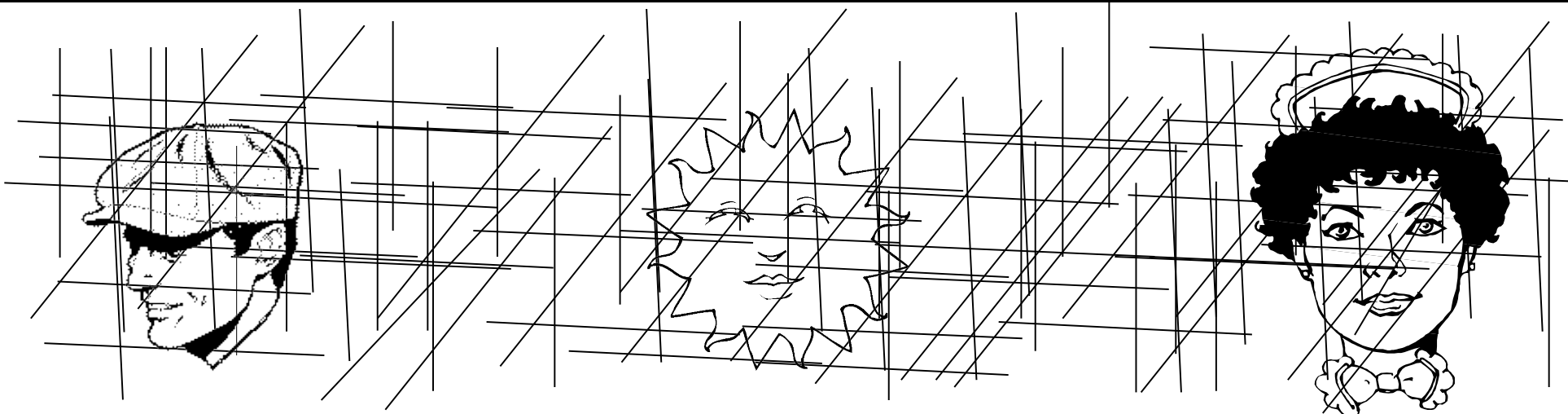
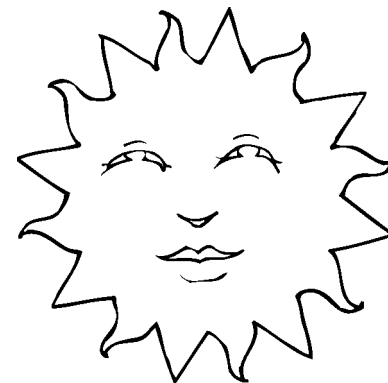

ASSOCIAZIONI LOGICHE

Far associare le immagini secondo un legame logico.

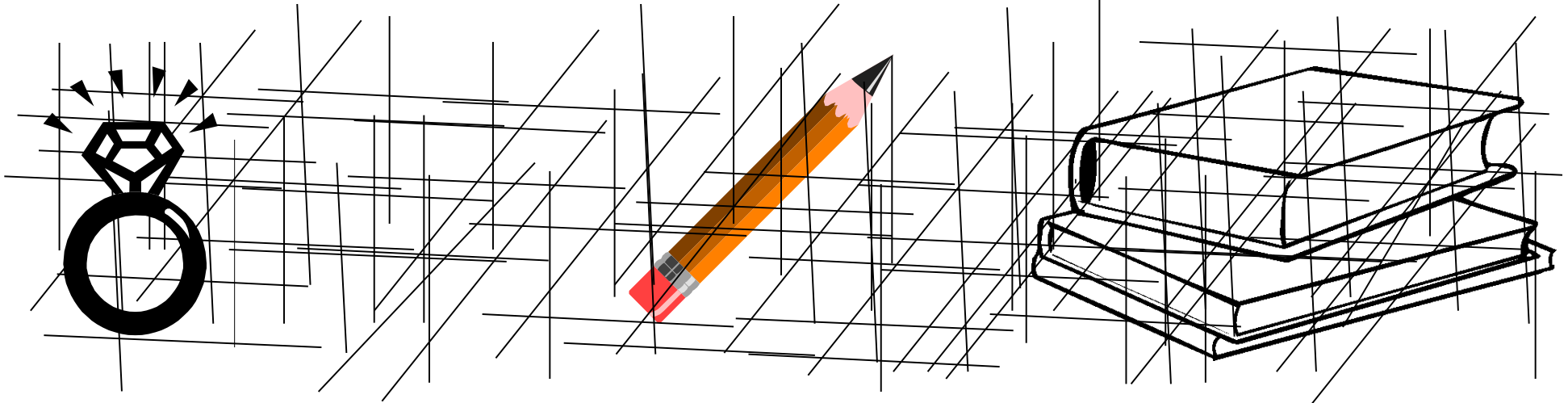
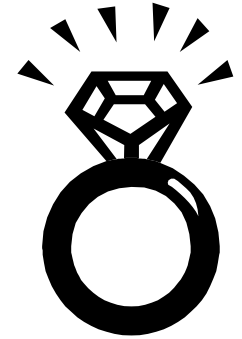
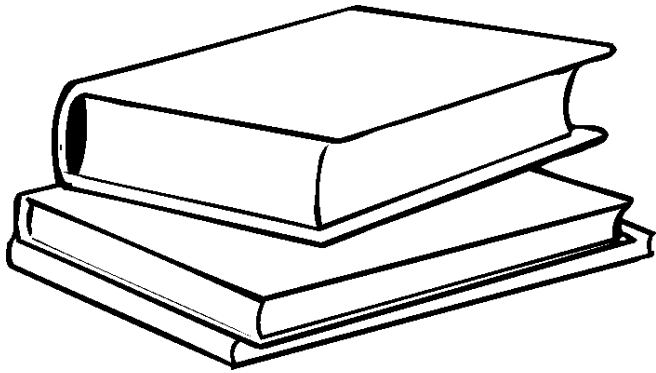

ASSOCIAZIONI LOGICHE

Far associare le immagini secondo un legame logico.

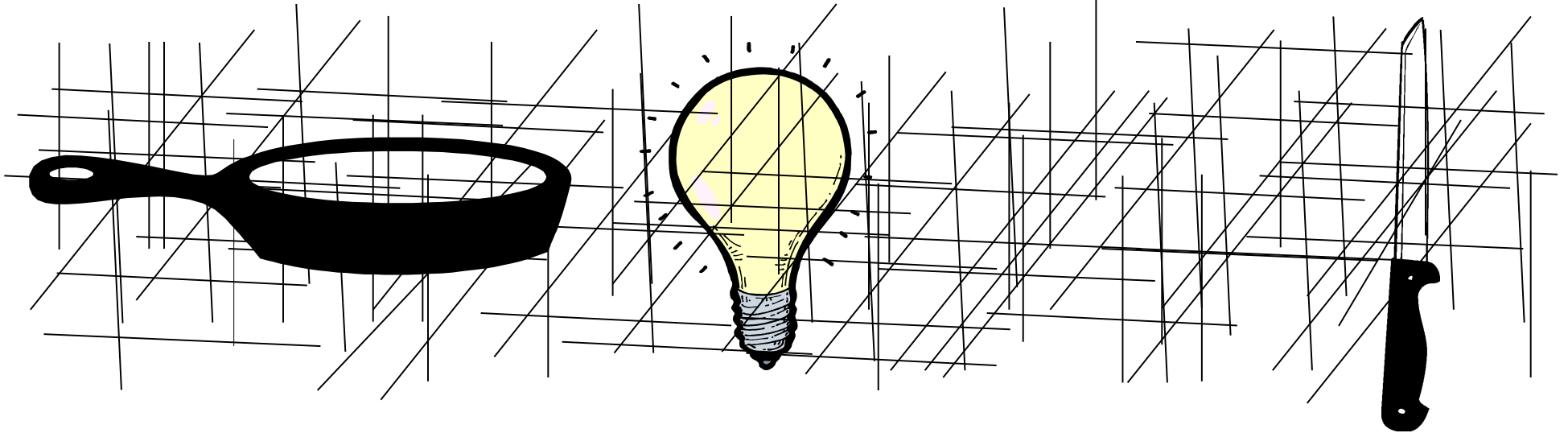
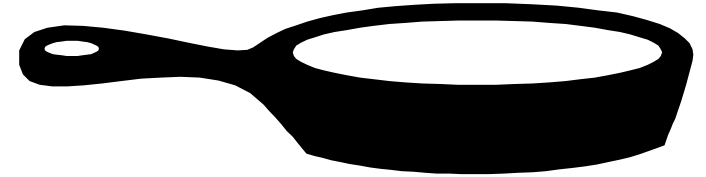
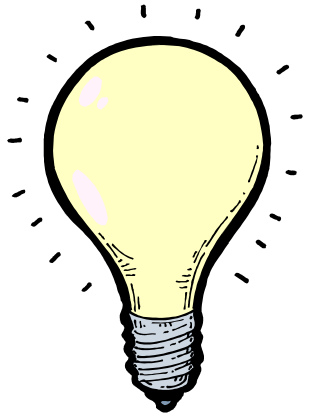

ASSOCIAZIONI LOGICHE

Far associare le immagini secondo un legame logico.

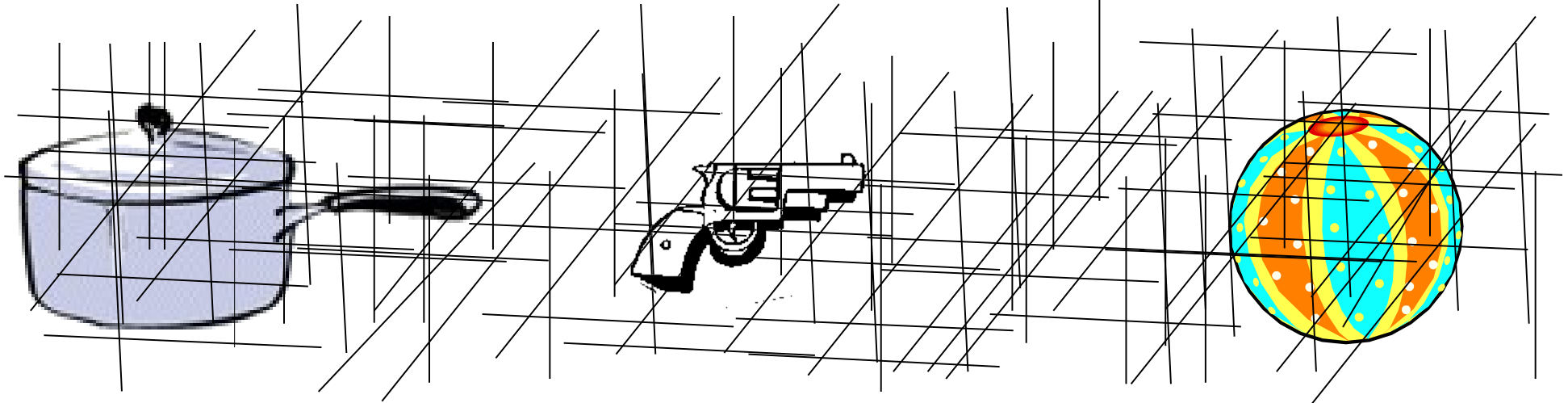
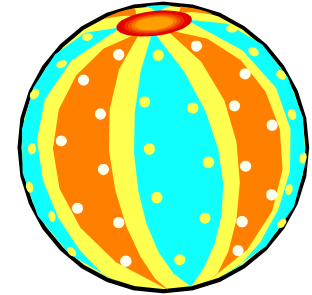

ASSOCIAZIONI LOGICHE

Far associare le immagini secondo un legame logico.

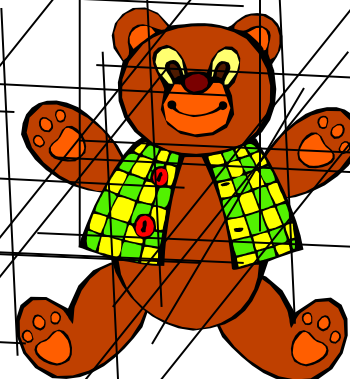
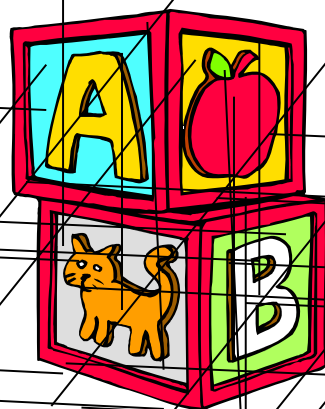
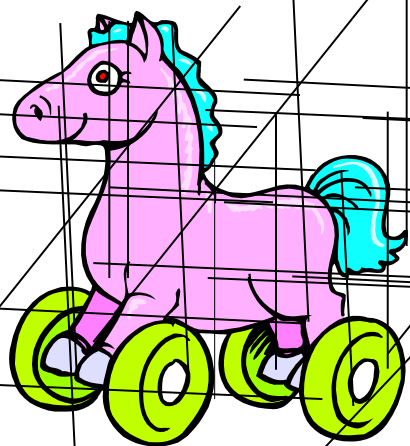
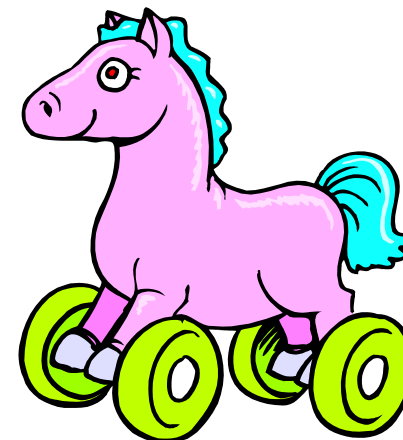
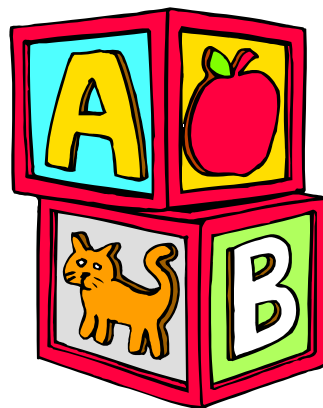

ASSOCIAZIONI LOGICHE

Far associare le immagini secondo un legame logico.

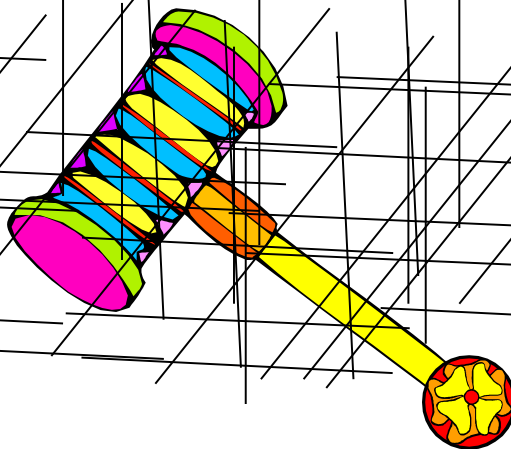
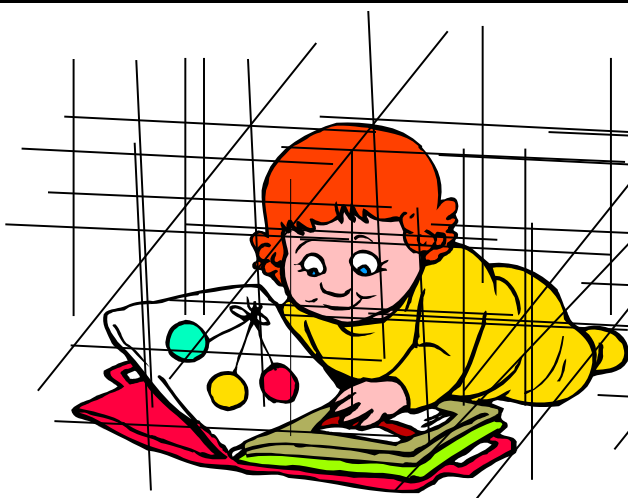
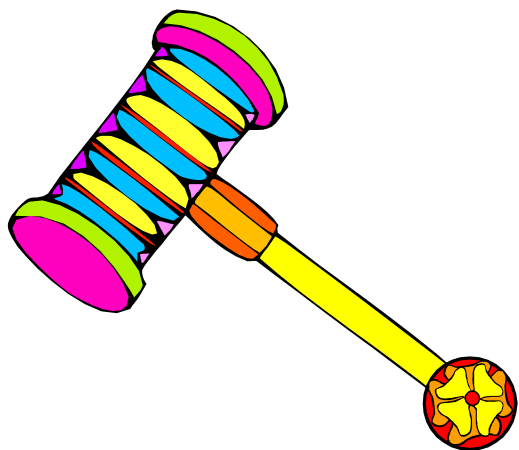

ASSOCIAZIONI LOGICHE

Far associare le immagini secondo un legame logico.

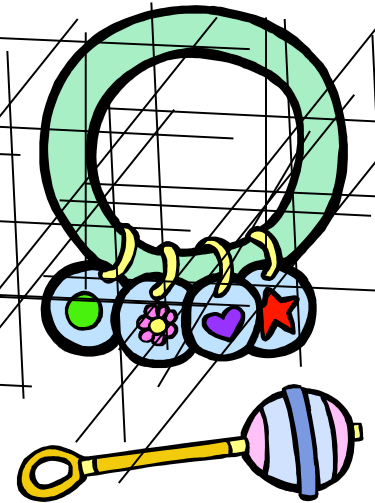
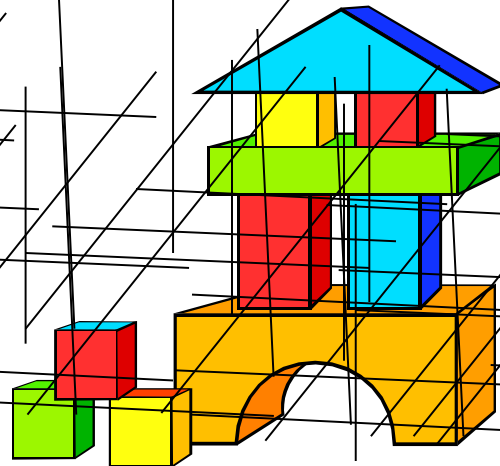
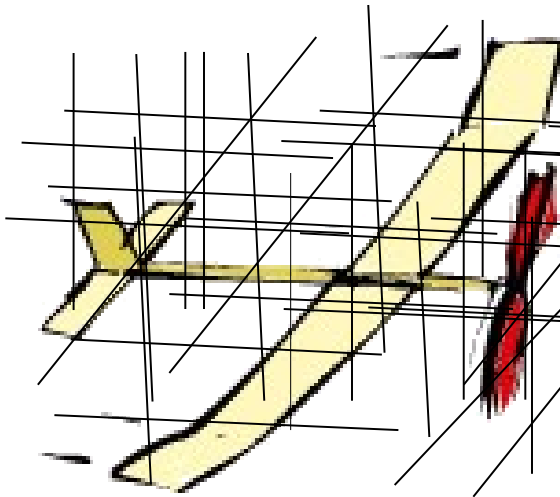
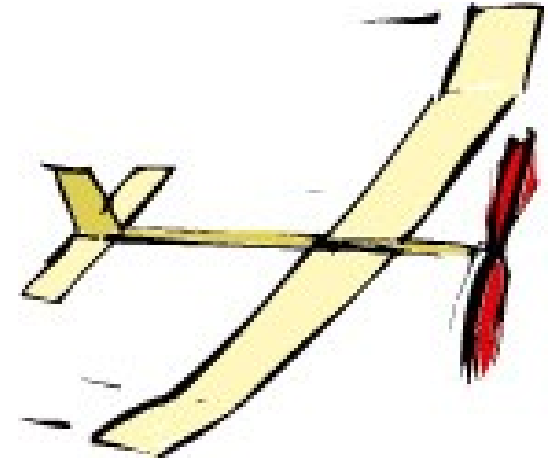
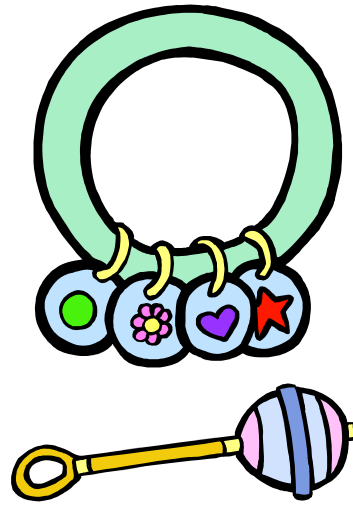
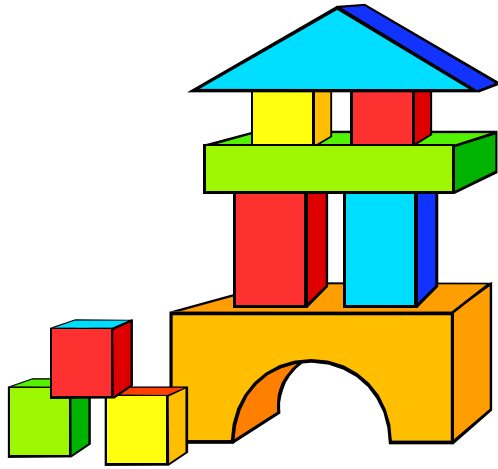

ASSOCIAZIONI LOGICHE

Far associare le immagini secondo un legame logico.

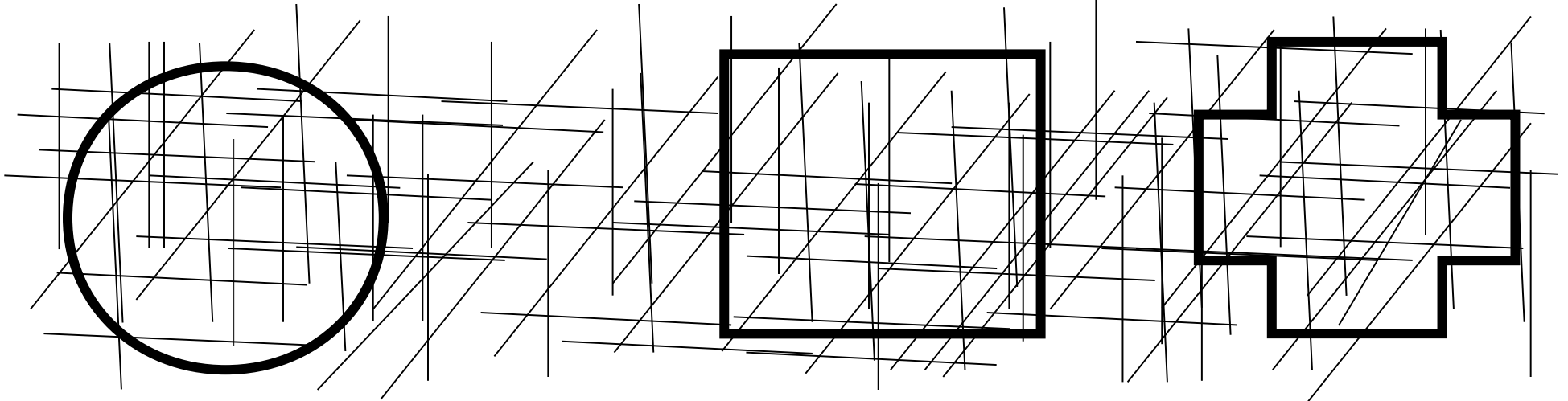
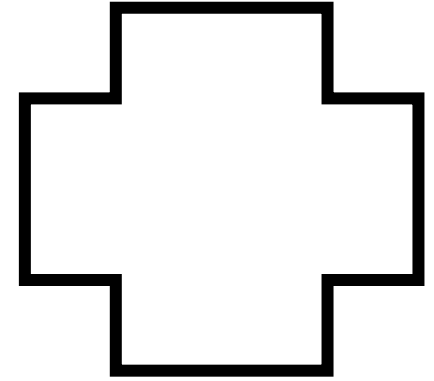
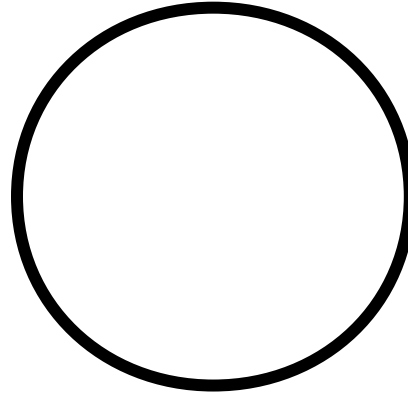

ASSOCIAZIONI LOGICHE

Far associare le immagini secondo un legame logico.

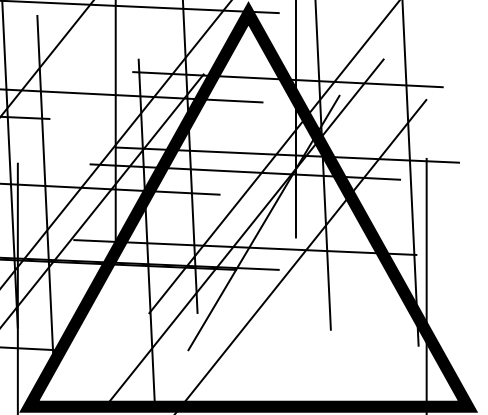
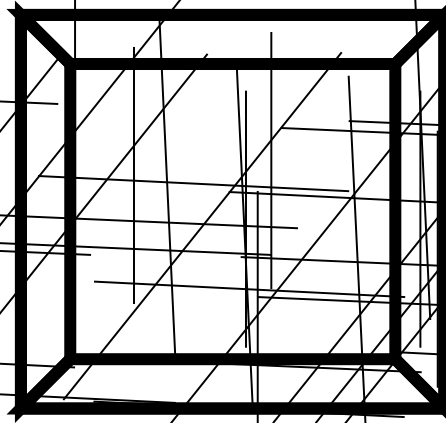
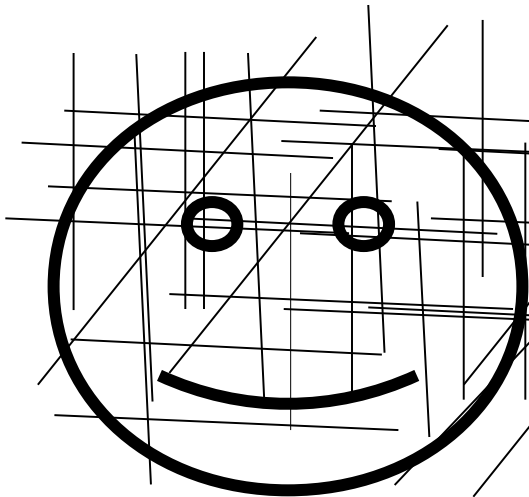
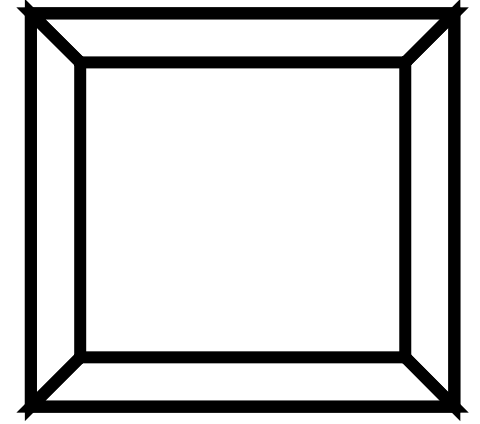
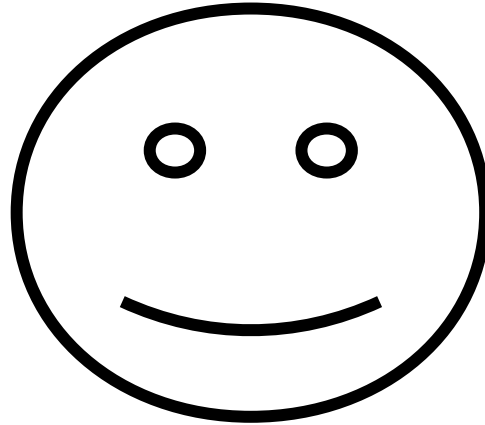
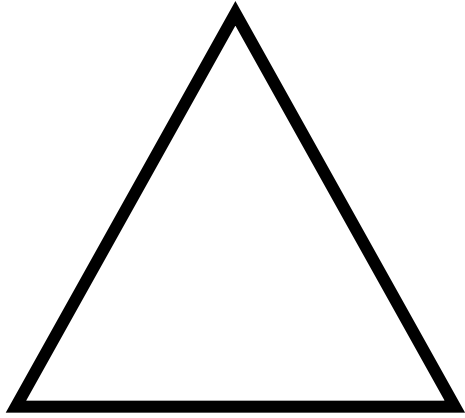

ASSOCIAZIONI LOGICHE

Far associare le immagini secondo un legame logico.

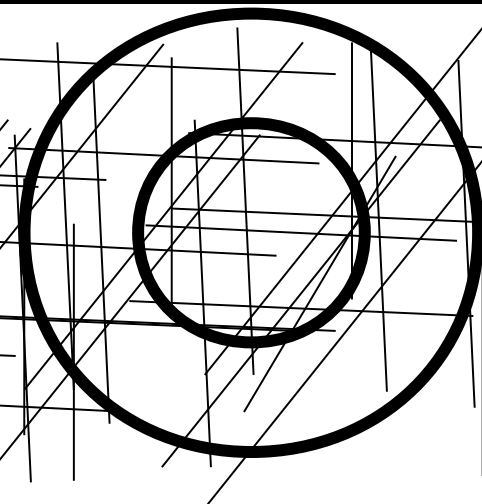
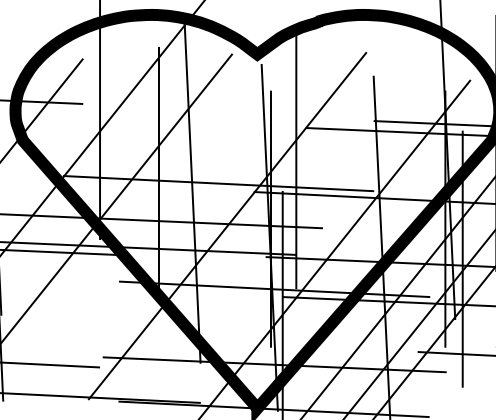
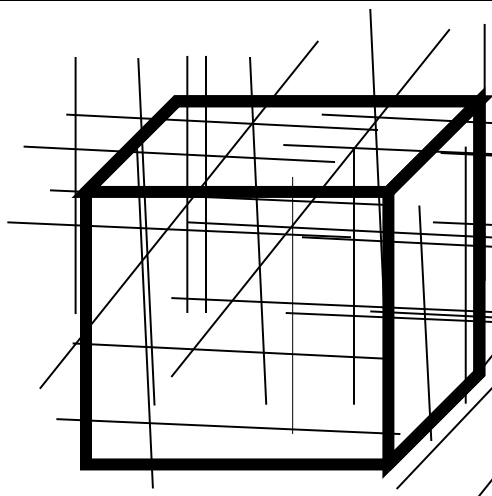
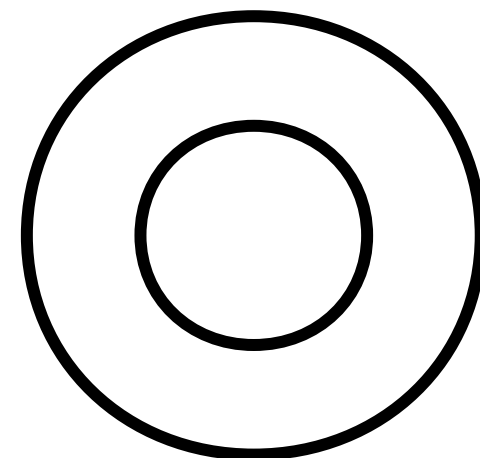
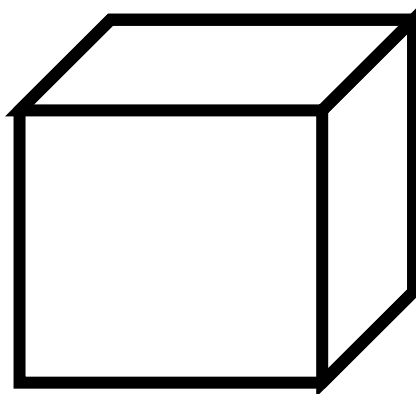
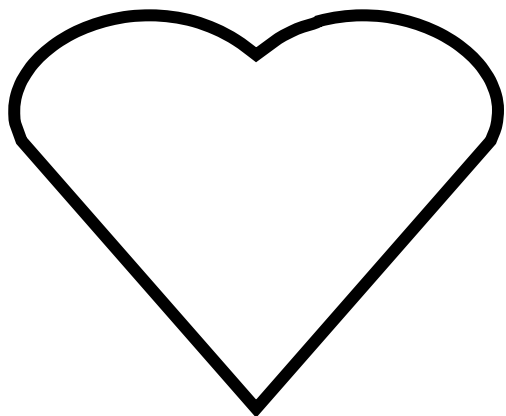

ASSOCIAZIONI LOGICHE

Far associare le immagini secondo un legame logico.

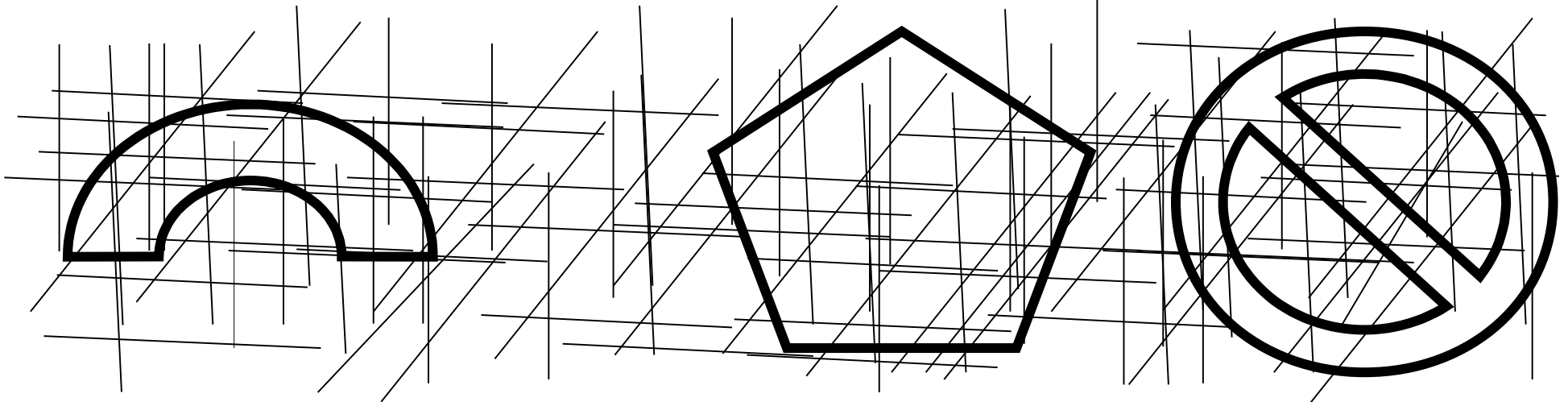
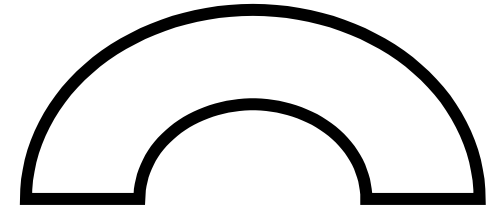
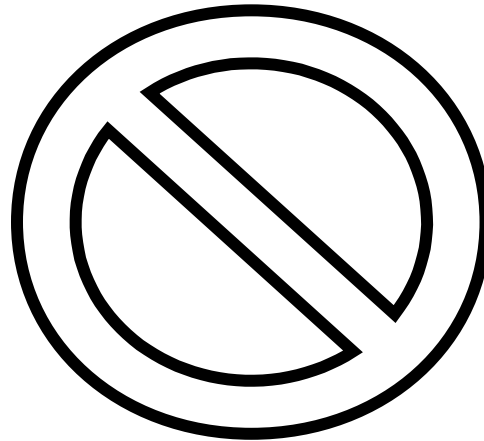
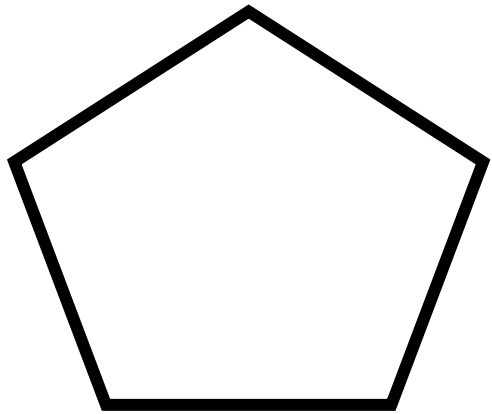

ASSOCIAZIONI LOGICHE

Far associare le immagini secondo un legame logico.

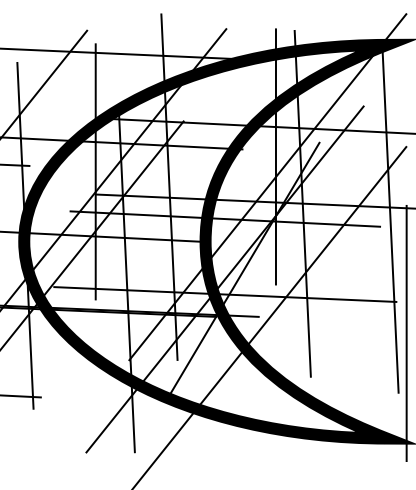
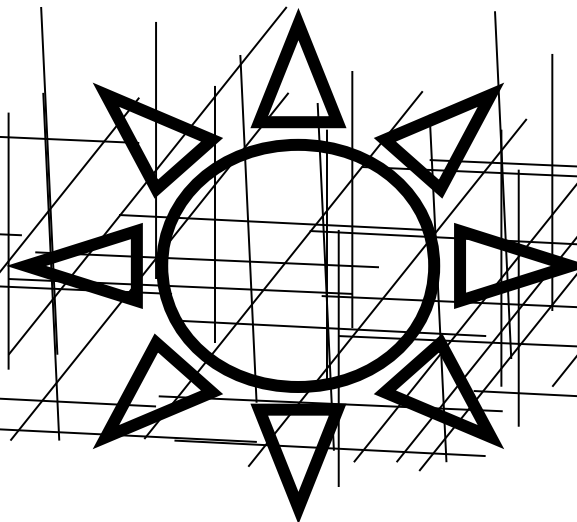
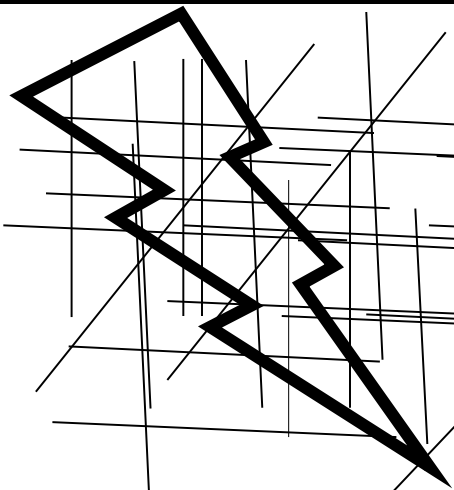
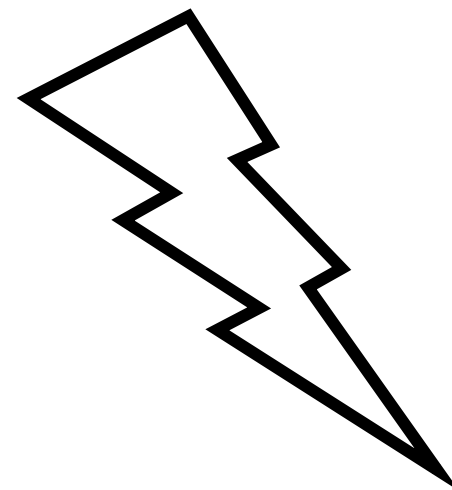
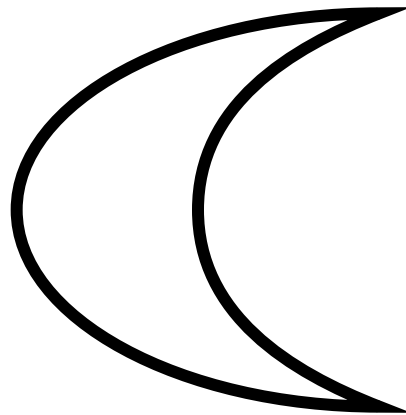
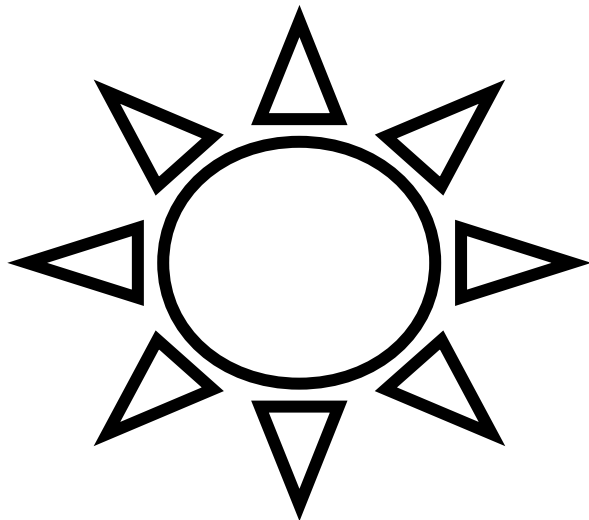

ASSOCIAZIONI LOGICHE

Far associare le immagini secondo un legame logico.

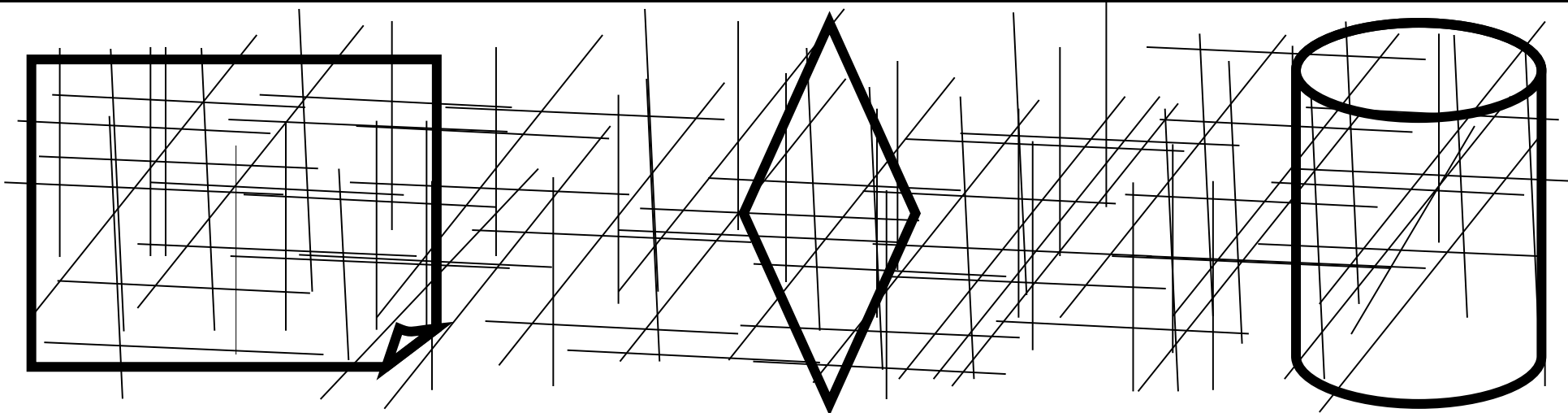
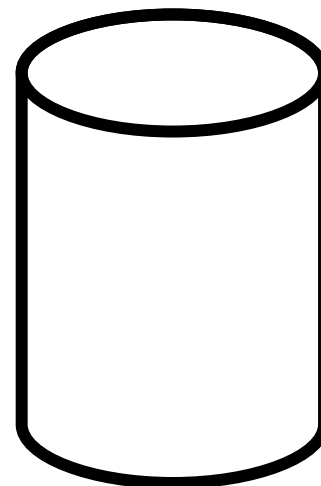
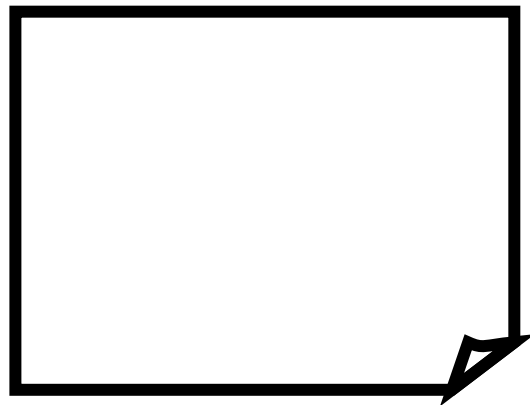
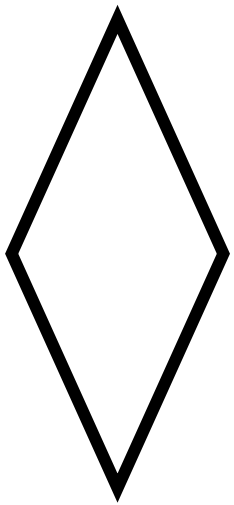

ASSOCIAZIONI LOGICHE

Far associare le immagini secondo un legame logico.

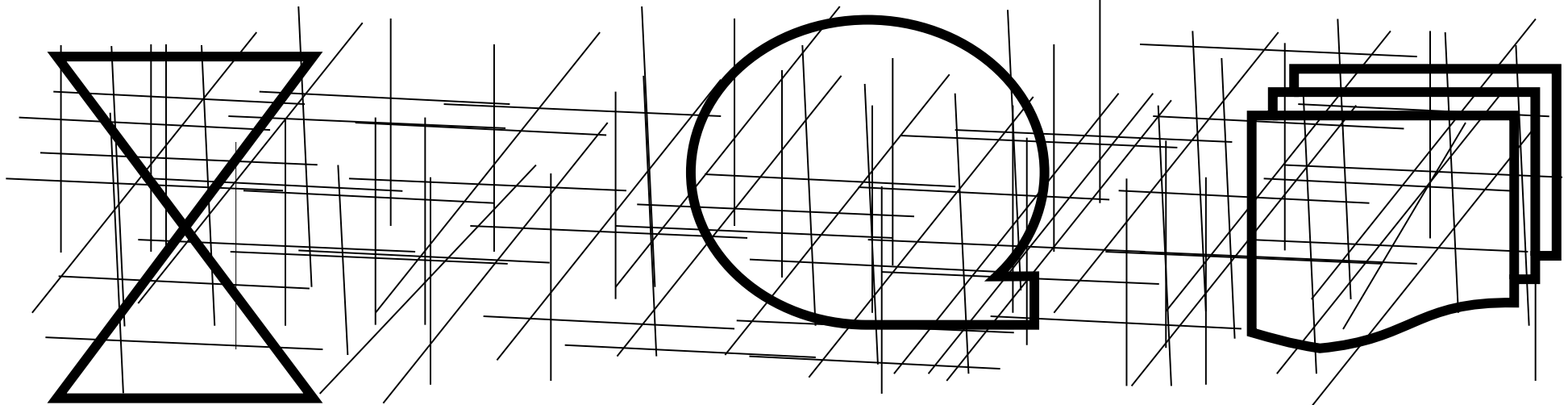
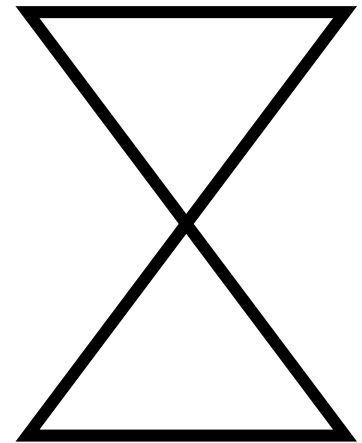
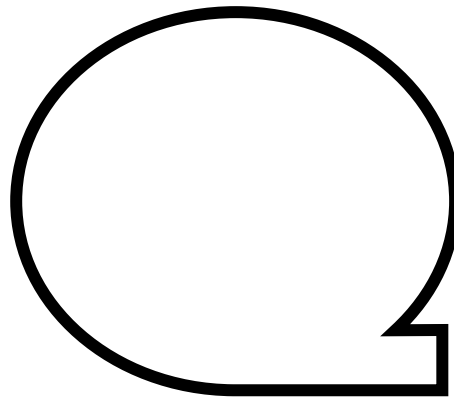
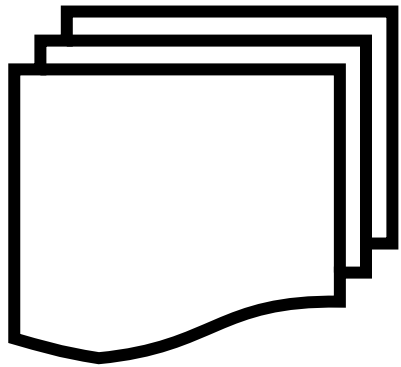

ASSOCIAZIONI LOGICHE

Far associare le immagini secondo un legame logico.

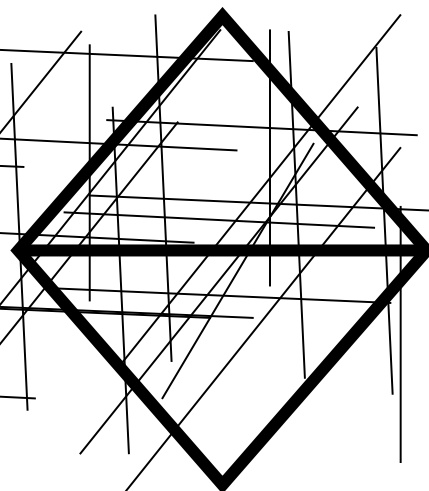
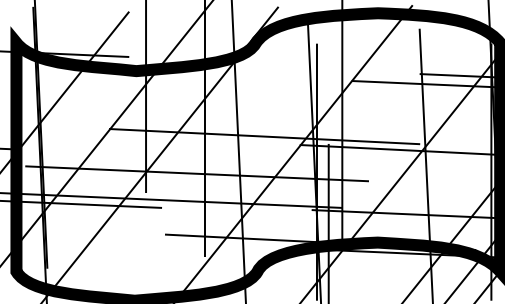
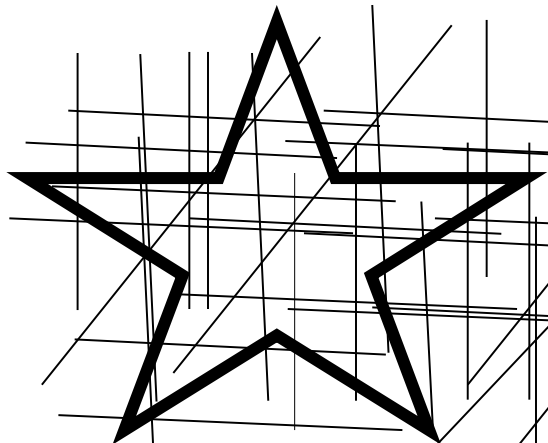
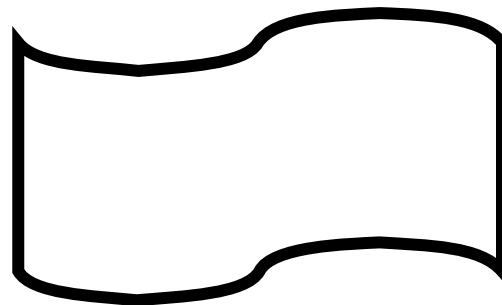
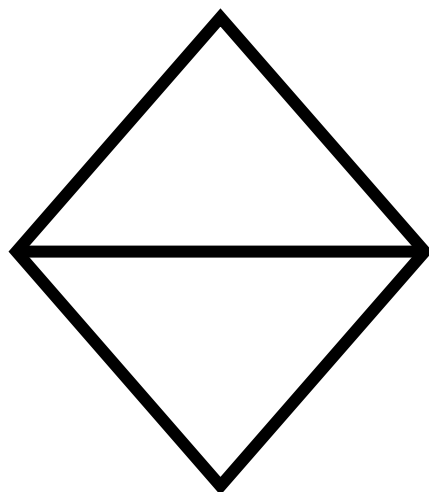
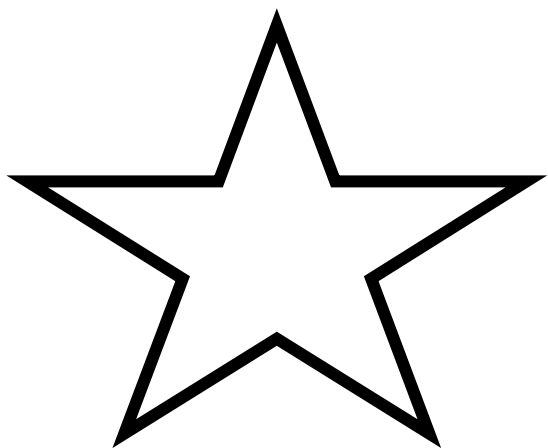

ASSOCIAZIONI LOGICHE

Far associare le immagini secondo un legame logico.

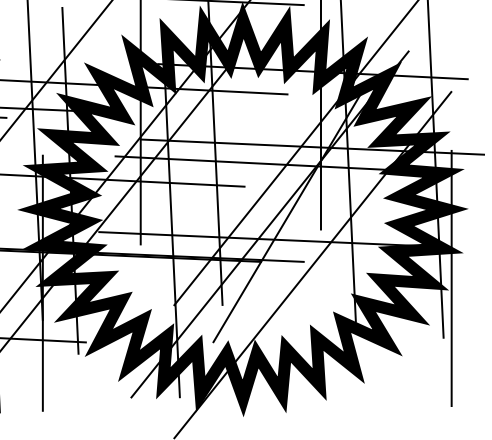
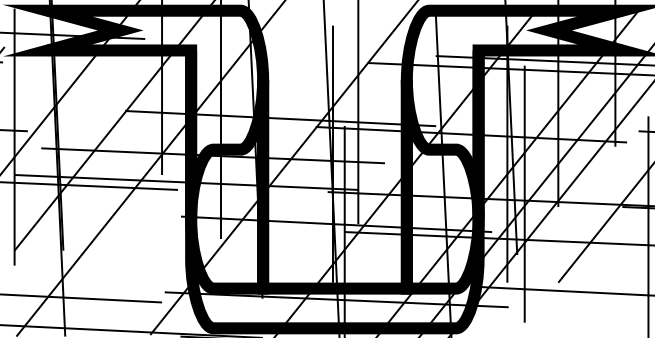
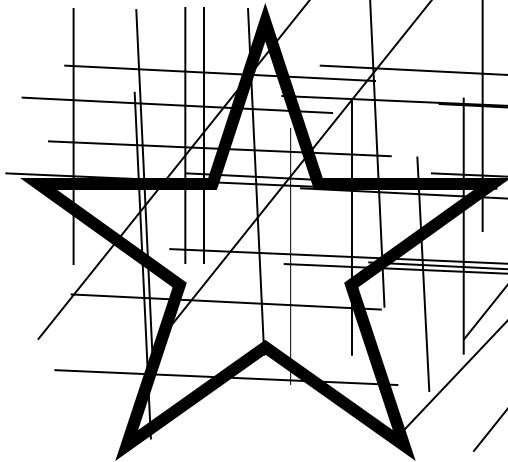
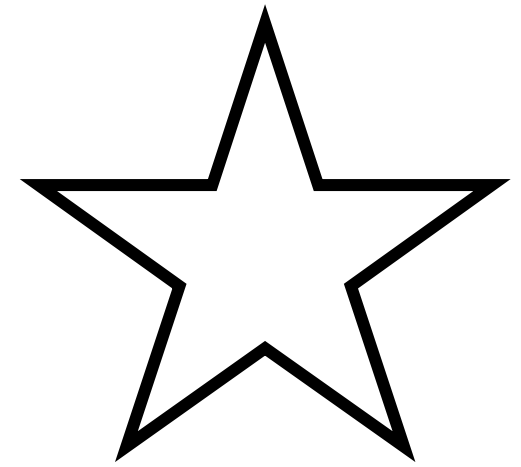
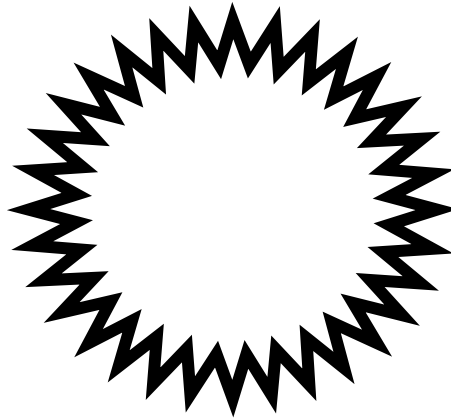
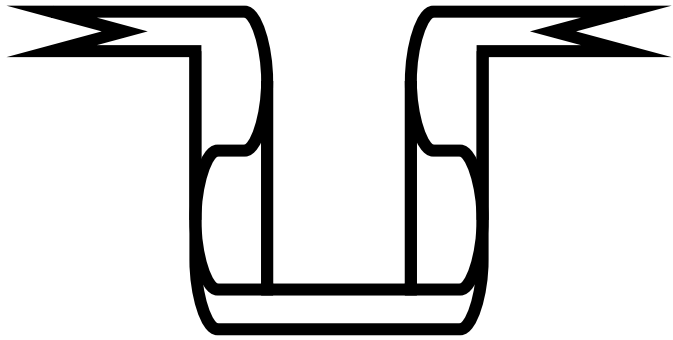

ASSOCIAZIONI LOGICHE

Far associare le immagini secondo un legame logico.

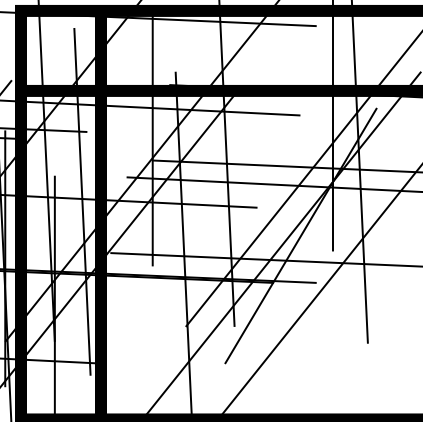
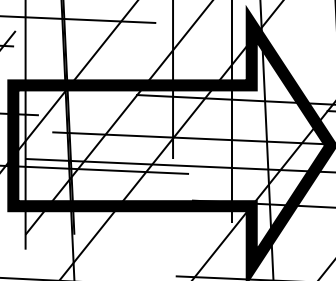
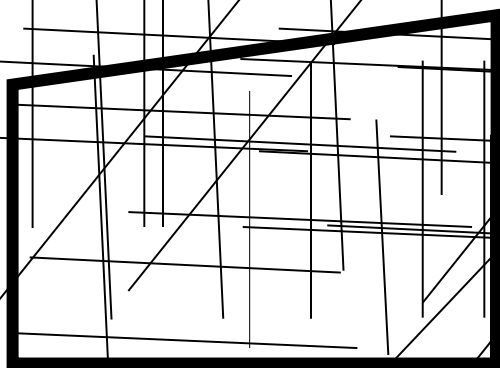
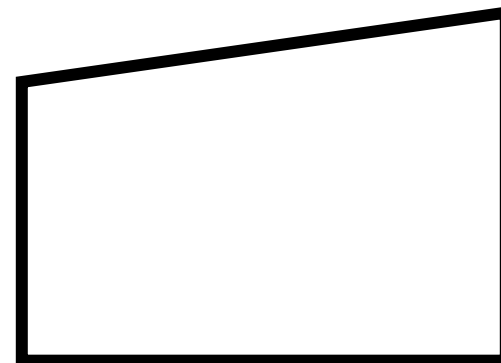
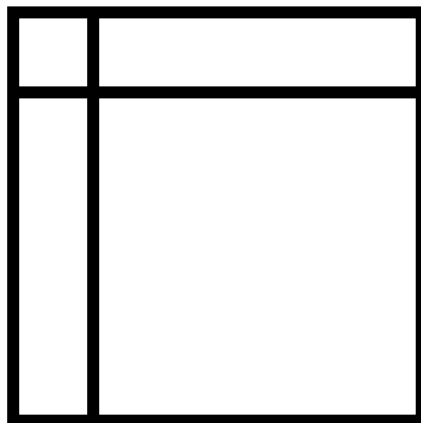
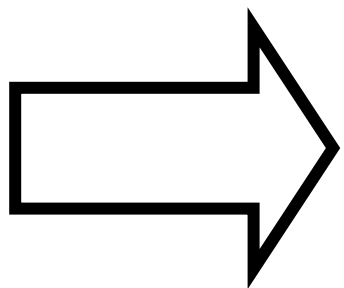

ASSOCIAZIONI LOGICHE

Far associare le immagini secondo un legame logico.

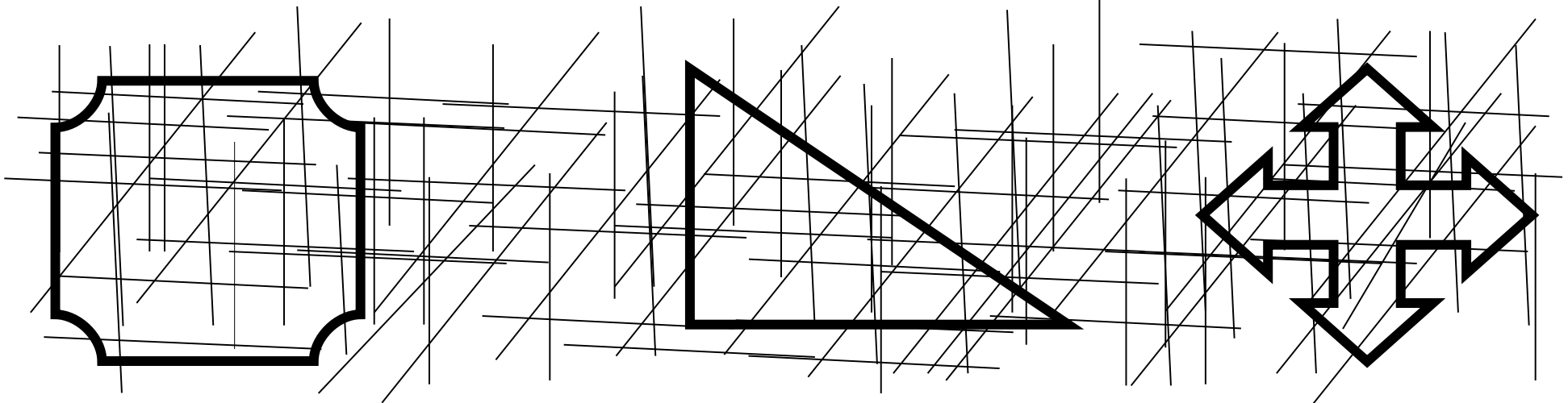
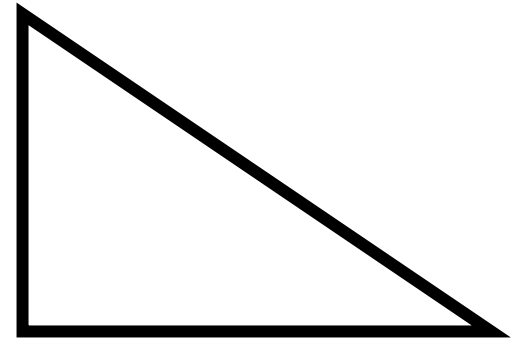
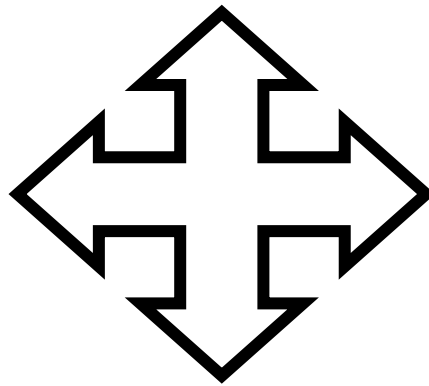
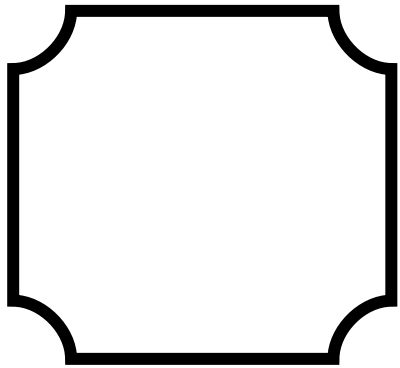

ASSOCIAZIONI LOGICHE

Far associare le immagini secondo un legame logico.